



RONGYI BUILDING MATERIALS

RONGYI BUILDING MATERIALS

PRODUCT CATALOGUE

-  Foshan Rongyi Building Materials Technology Co.,Ltd
-  No 183, Rd. Yinshibei, Shishan Town, Foshan, GuangDong, China
-  Official Website : <https://rongyijckj.com/>
Alibaba: <https://rongyikeji.en.alibaba.com/>
Facebook: <https://www.facebook.com/ry.tiletrim>



Official Website



FB



alibaba

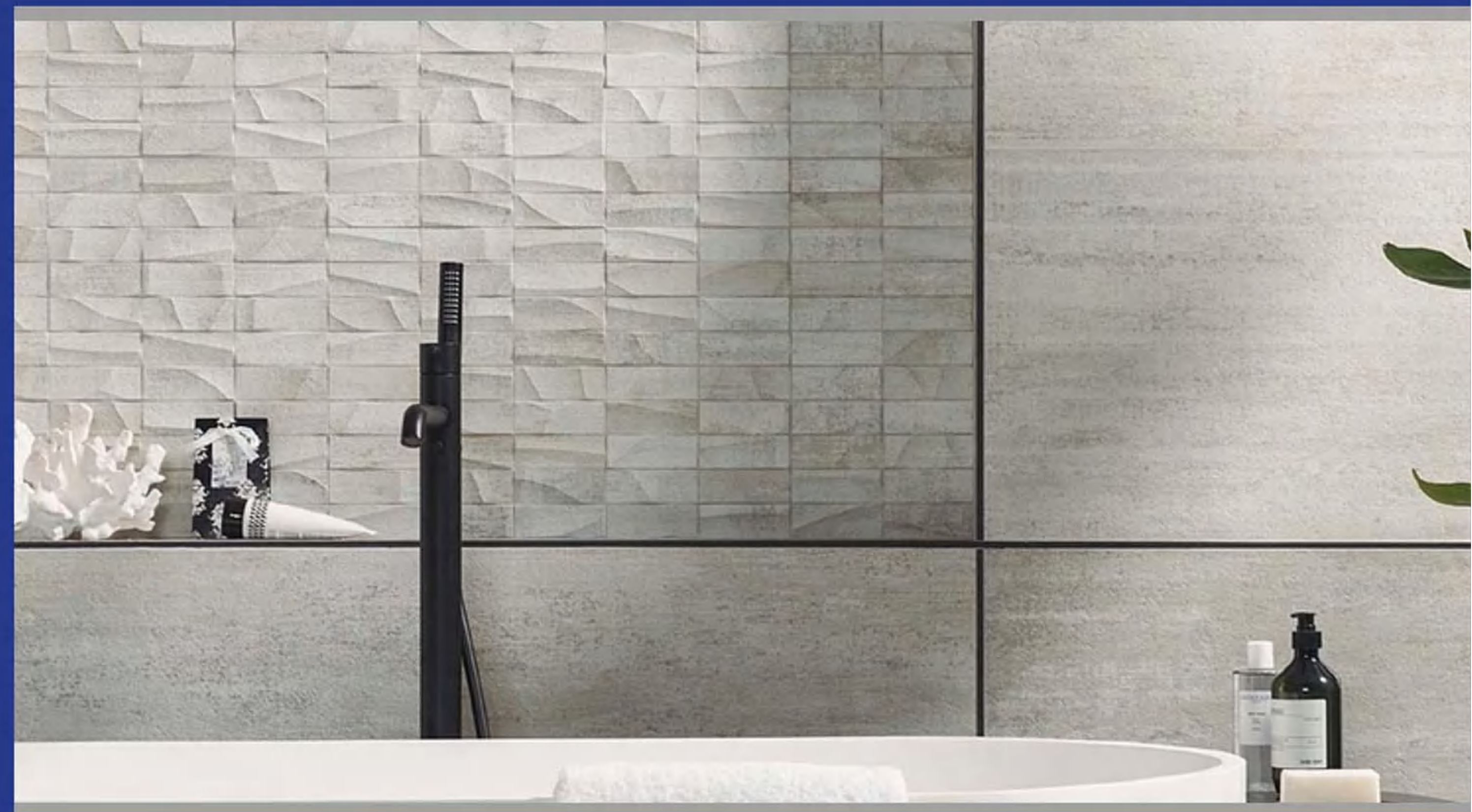

FOSHAN RONGYI BUILDING MATERIALS TECHNOLOGY CO., LTD.

The factory covers an area of about 5000 square meters, more than 100 employees, with advanced production equipment.

16 YEARS⁺

PRODUCTION
TILE TRIM
MANUFACTURING



Factory direct sale



Free samples



On time delivery

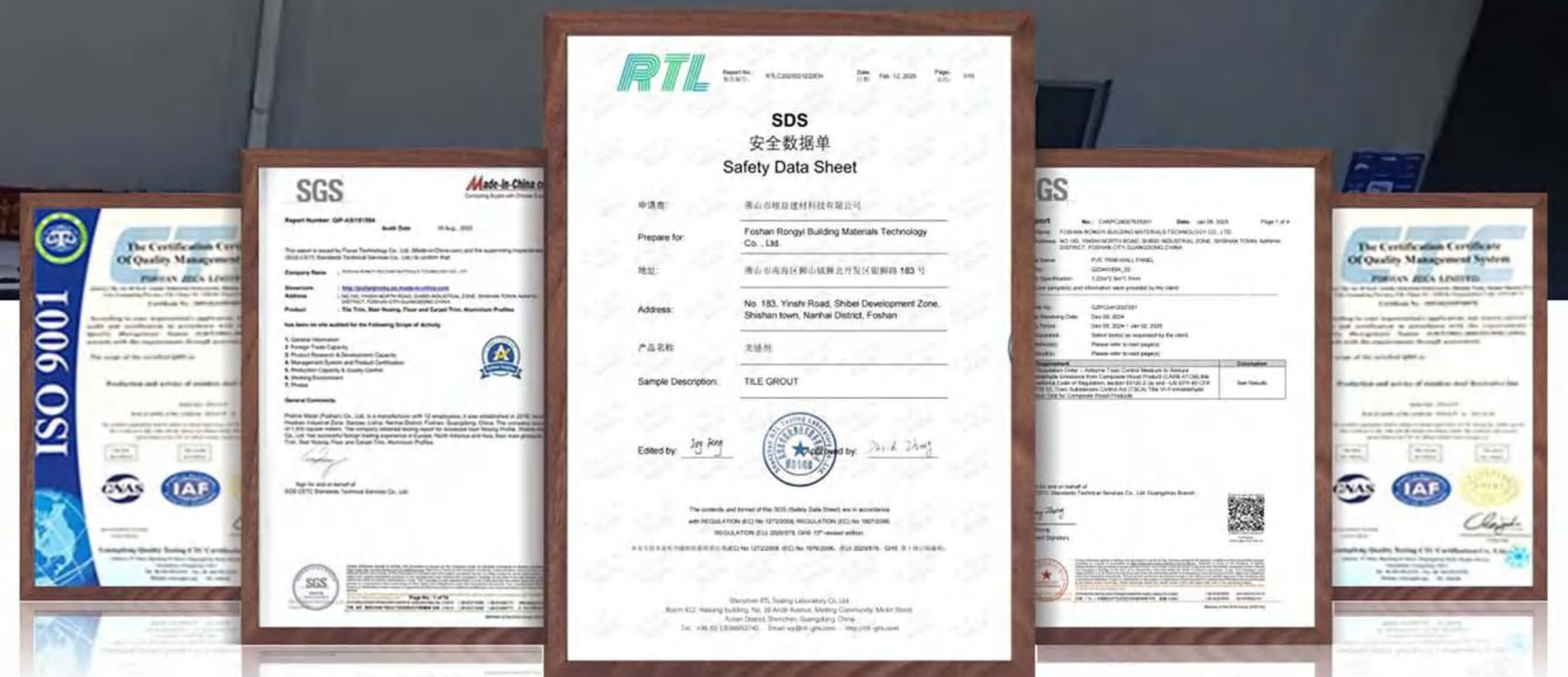



OUR HEADQUARTERS

WELCOME TO ROUYI

CONTACT INFORMATION

We would like to introduce ourselves. We are a passionate team of people who are always there for you and ready to help you with any need. You can count on that!

"dedicate to innovation, do the best on every product" is the purpose of the enterprise. With our wide range of products that we offer today, you can fully concentrate on your performance and your professional field as we will take care of the materials, advice, and service. A huge selection of high quality products, excellent advice service on the phone, via chat on our website, or directly at your stores and projects.

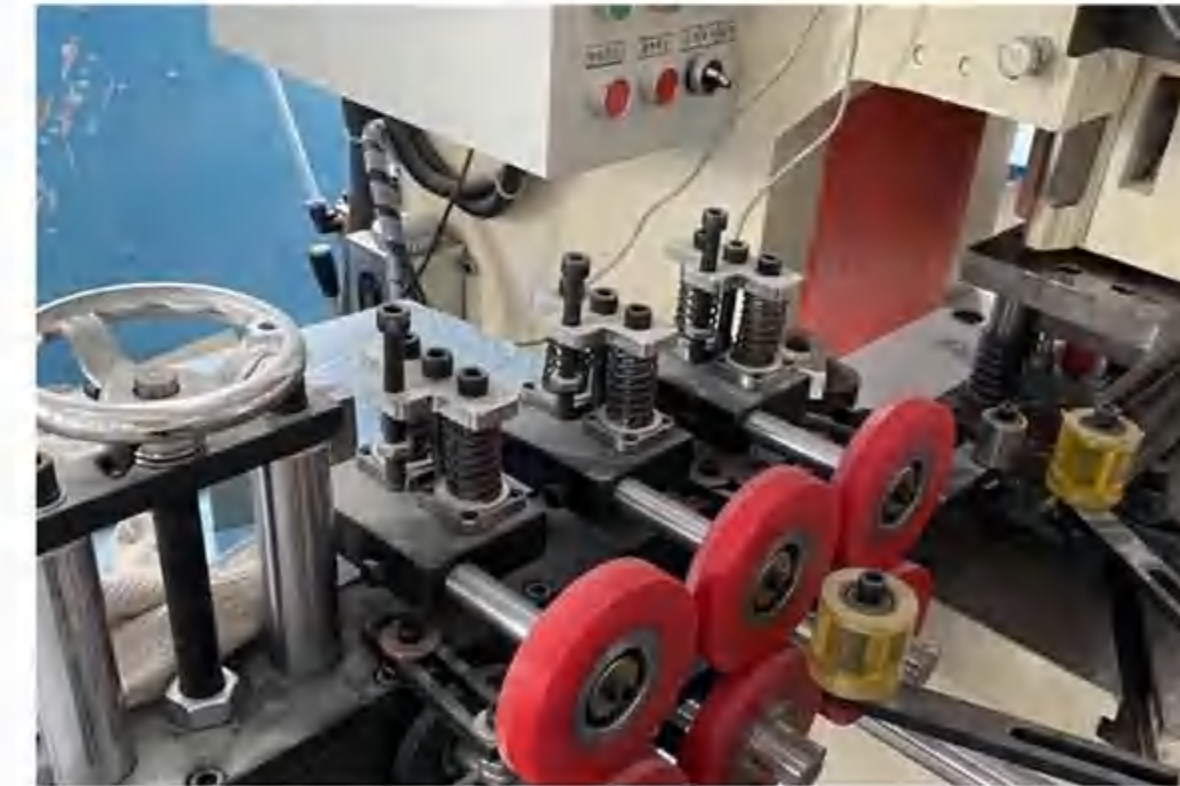

PRODUCTION
LOGISTICS WAREHOUSE



PACKAGING AND STORAGE





TILE TRIM

Product Catalogue

PRODUCT SERIES

- 1** PVC tile trim
p5~p8
- 2** Aluminium tile trim
p11~p30
- 3** Stainless steel tile trim
p33~p44
- 4** Stainless steel decorative strip
p45~p46
- 5** Skirting board
p47~p50
- 6** LED Profile
p51~p54
- 7** Tile leveling system
p55~p60
- 8** Tile grout
p61~p64
- 9** Team/Global partners
p65~p66

PRODUCT FEATURE

Aesthetic appeal

Tile decorative strips come in a variety of designs and colors, seamlessly blending with different interior styles and enhancing overall beauty.

Easy to Clean

The smooth surface of tile strips prevents dust and dirt accumulation, making cleaning and maintenance quick and effortless.

Waterproof

Tile decorative strips boast excellent waterproof properties, making them ideal for use in kitchens and bathrooms, effectively preventing mold growth.



STONE PVC
Open shape

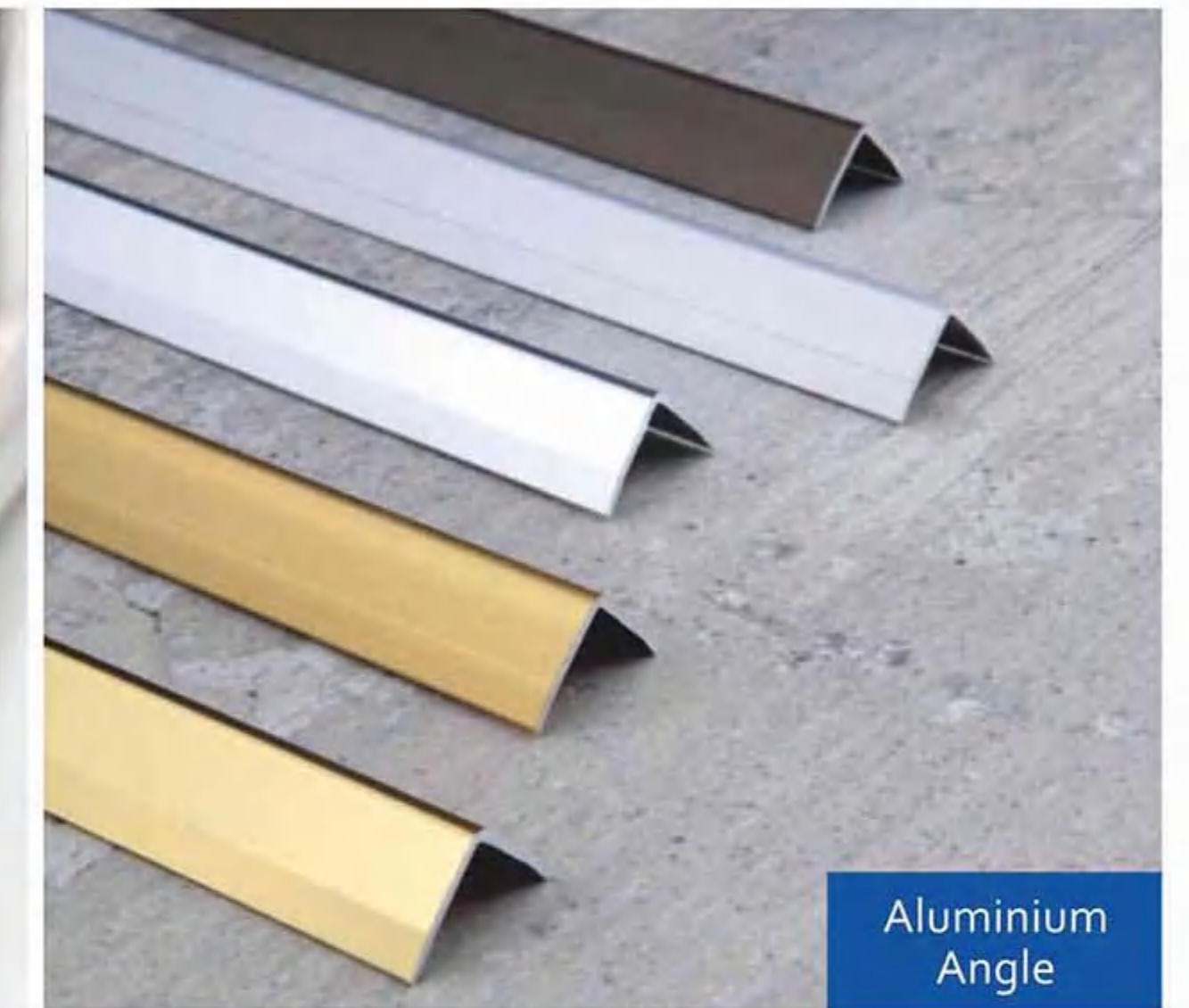

Aluminium
Angle



PVC
Open shape



Aluminium
tile trim

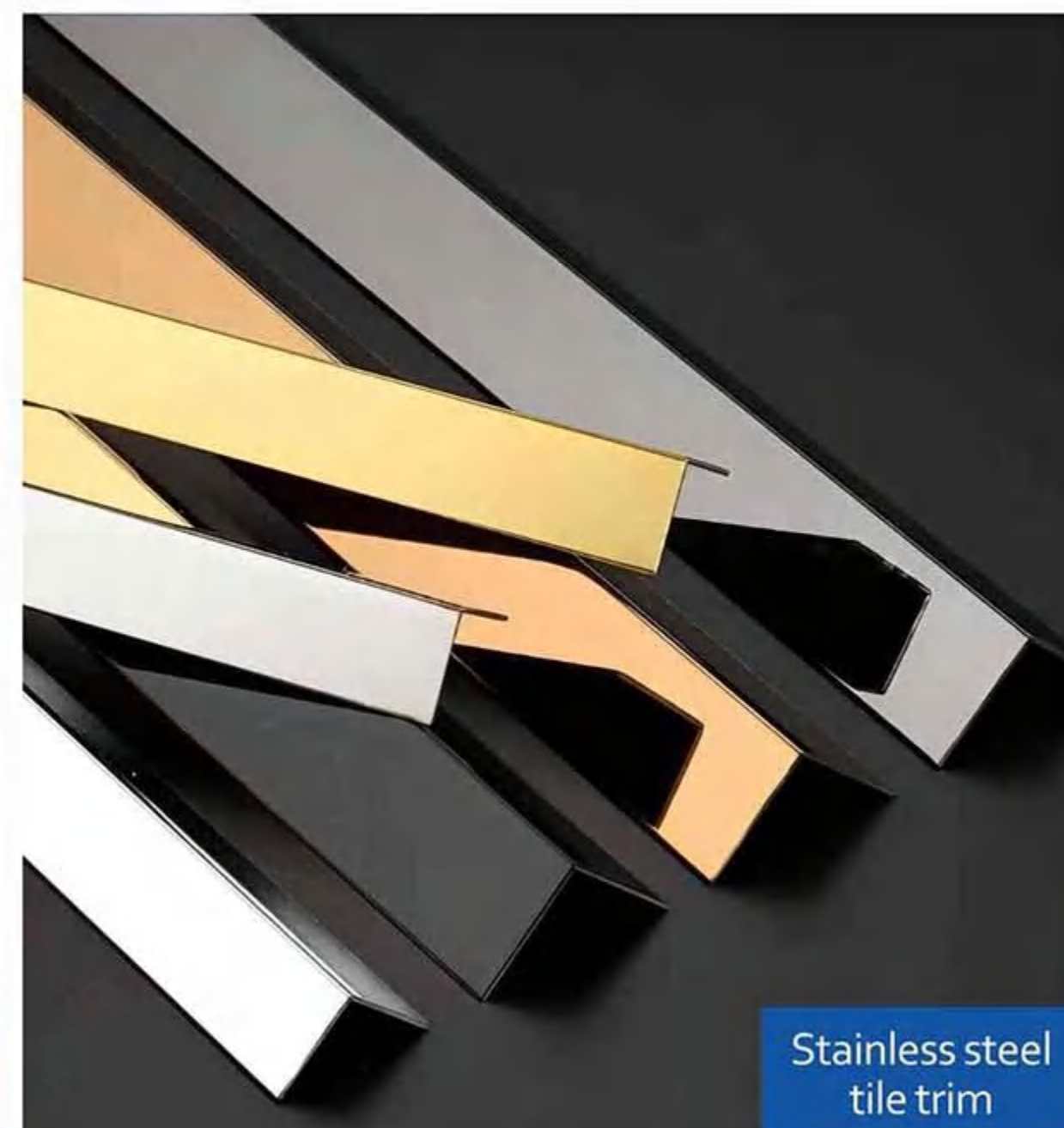

Stainless steel
tile trim

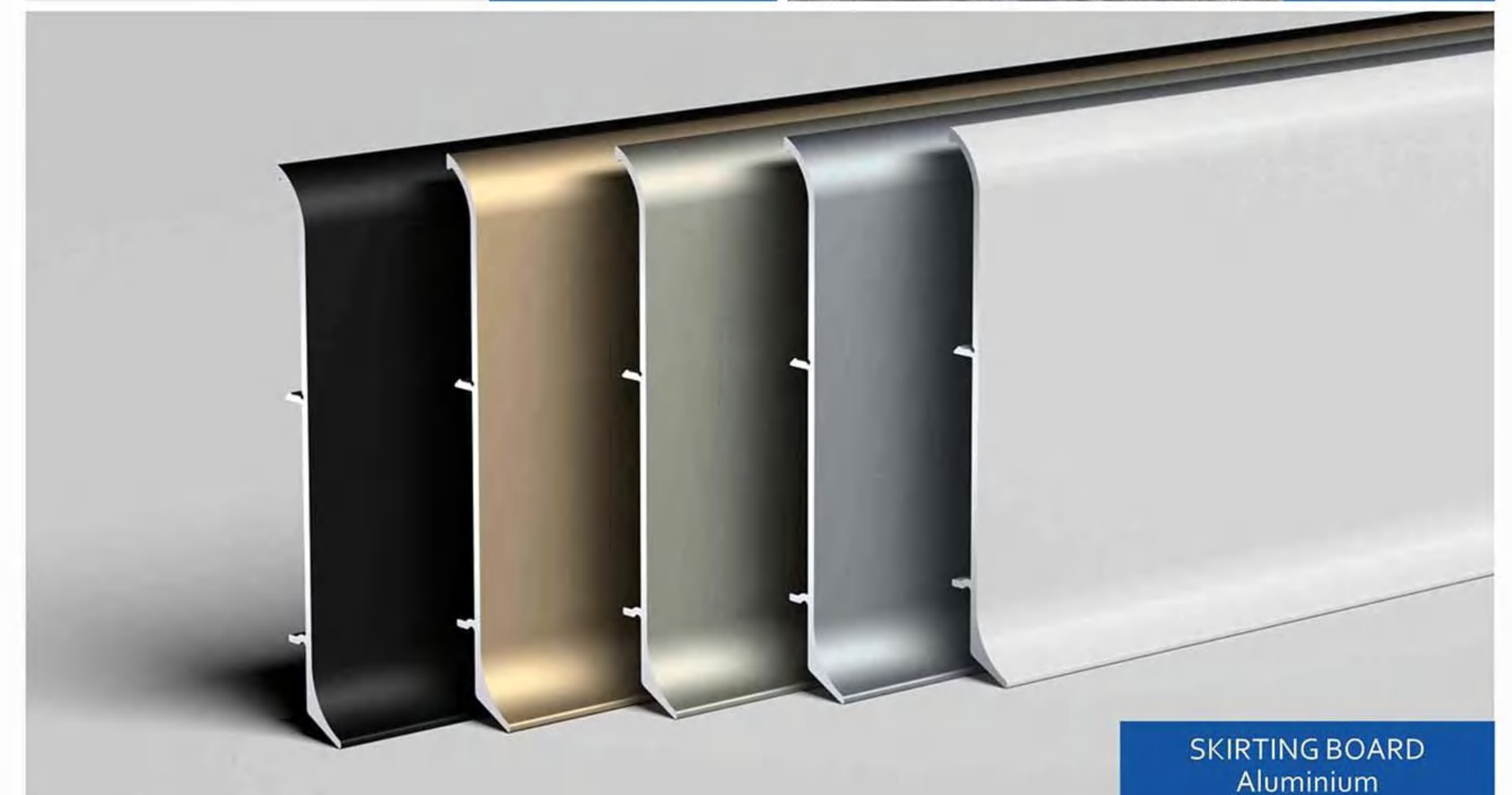

SKIRTING BOARD
Aluminium



PVC TILE TRIM

Tile decorative strips come in a variety of designs and colors, seamlessly blending with different interior styles and enhancing overall beauty.



STONE PVC TILE TRIM

榕益 ROUYI
FREE DESIGN AND OEM









ASSEMBLY DRAWING

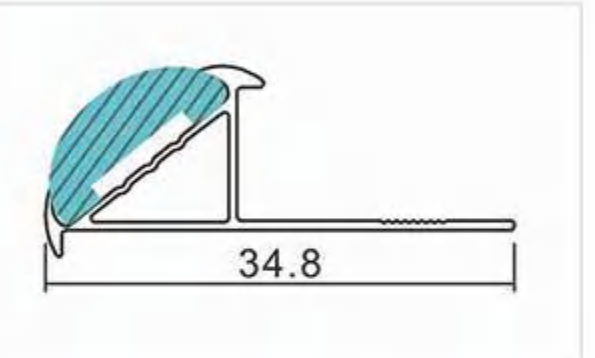

Height	Length	Thickness	Remark
8mm/0.315in	2500~3000mm 8.2ft~9.84ft	2.0(mm) 0.078in	Size can be customized.
10mm/0.394in			
12mm/0.472in			

CAD LINE GRAPH

Rongyi Building Materials

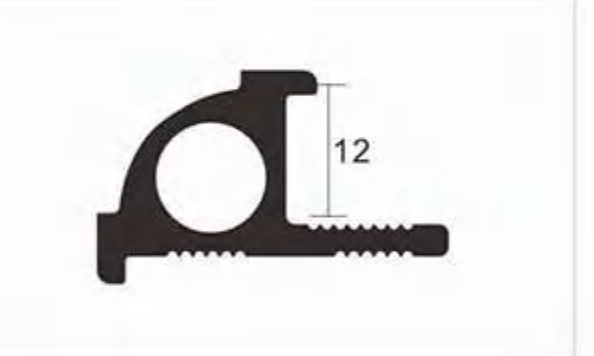
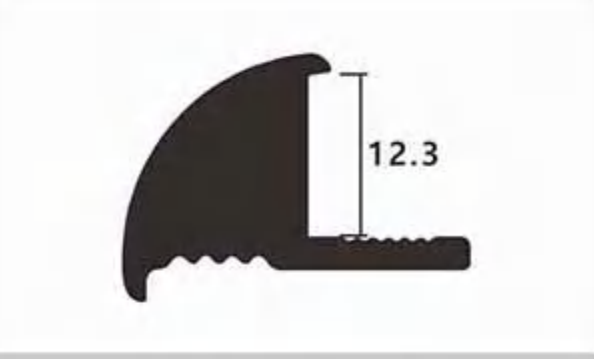
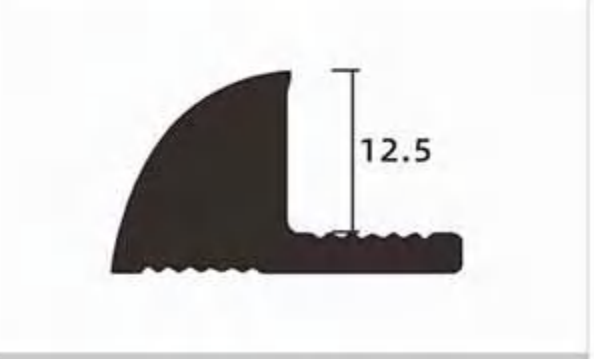
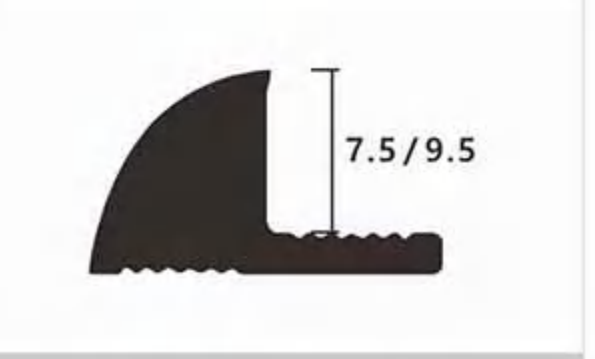
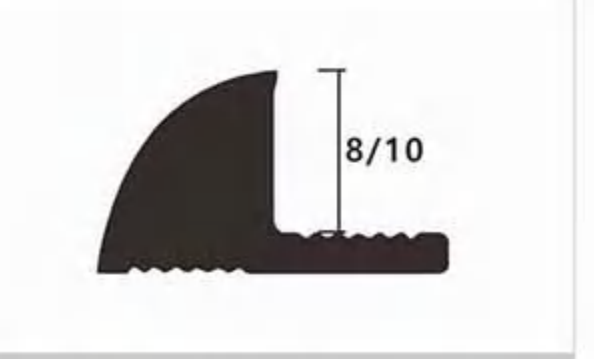
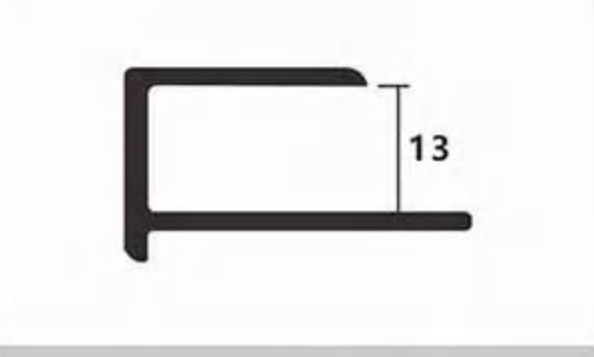
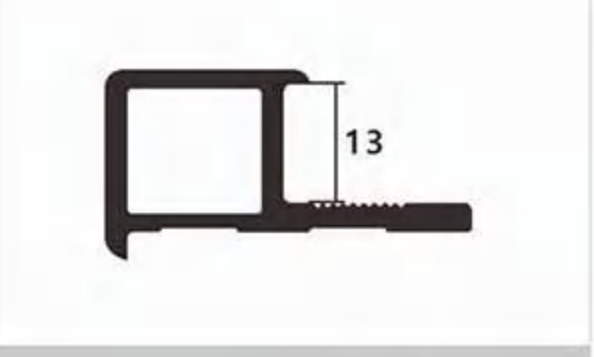
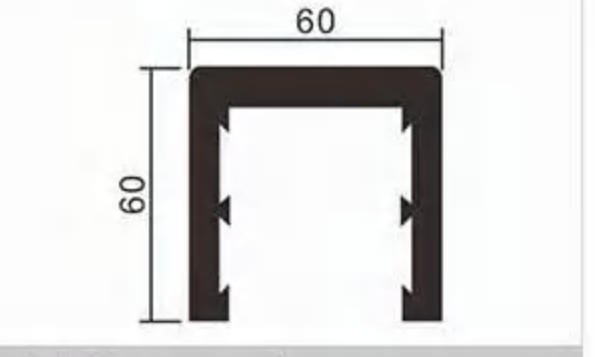
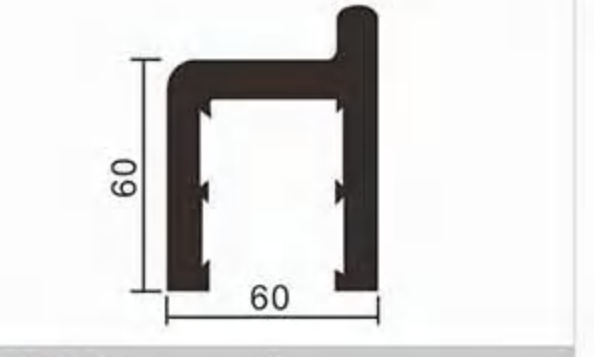
 Angle L 10*10 /20*20 L 25*25 /30*30	 Thin angle 15*15 30*30	 PVC Insert Aluminium	 ITEM NO: 53
 ITEM NO: 42	 ITEM NO: 42-1	 ITEM NO: 32	 ITEM NO: 61
 ITEM NO: 65	 ITEM NO: 85	 ITEM NO: 75 / 95	 ITEM NO: 85-8 / 85-10
 ITEM NO: 81	 ITEM NO: 82	 Water stopper A 6*6*7.2	 Water stopper B 6*6*6

ASSEMBLY DRAWING

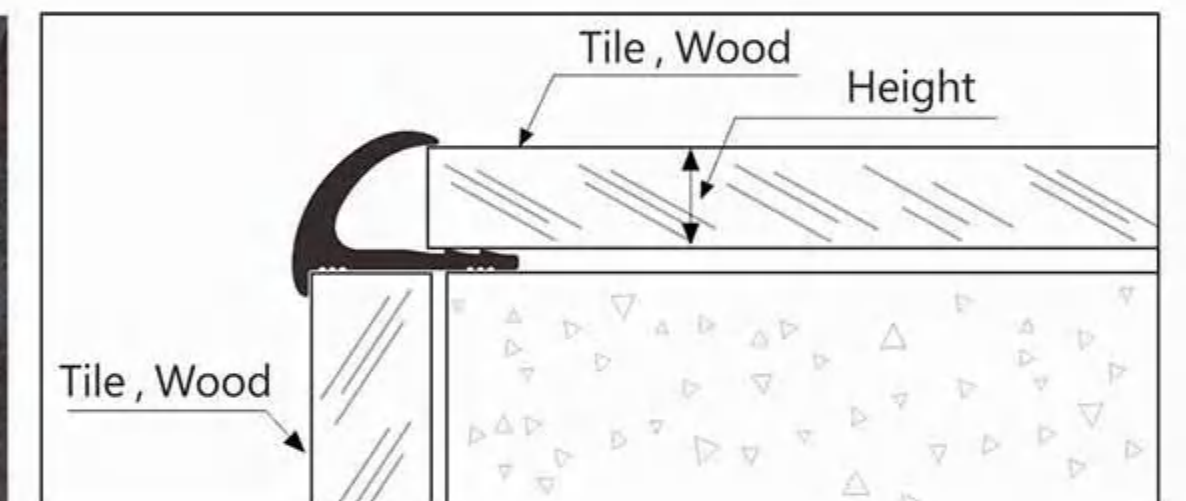

Height	Length	Thickness	Remark
8mm/0.315in	2500~3000mm 8.2ft~9.84ft	2.0(mm) 0.078in	Size can be customized.
10mm/0.394in			
12mm/0.472in			

PVC TILE TRIM



Colors Surface
Any color can be customized

ASSEMBLY DRAWING



Height	Length	Thickness	Remark
8mm/0.315in	2500~3000mm 8.2ft~9.84ft	1.0~1.2(mm) 0.04~0.047in	Size can be customized.
10mm/0.394in			
12mm/0.472in			

CAD LINE GRAPH

Terrazzo strip 水磨条	Trunking 线槽	Trunking 线槽	Trunking 煤气管道
Umbrella 伞型款	RO10-A RO10-B 开口款	RO12-A RO12-B 开口款	RC-8 封口款
RC-10/12 封口款	TWRC-10/12 封口款	RC10-A 封口带角	Square-10 方型10
Slant-10 斜口款	Slant-12 斜口款	Inner corner PVC阴角	Angle L12-1 L12-2

ASSEMBLY DRAWING

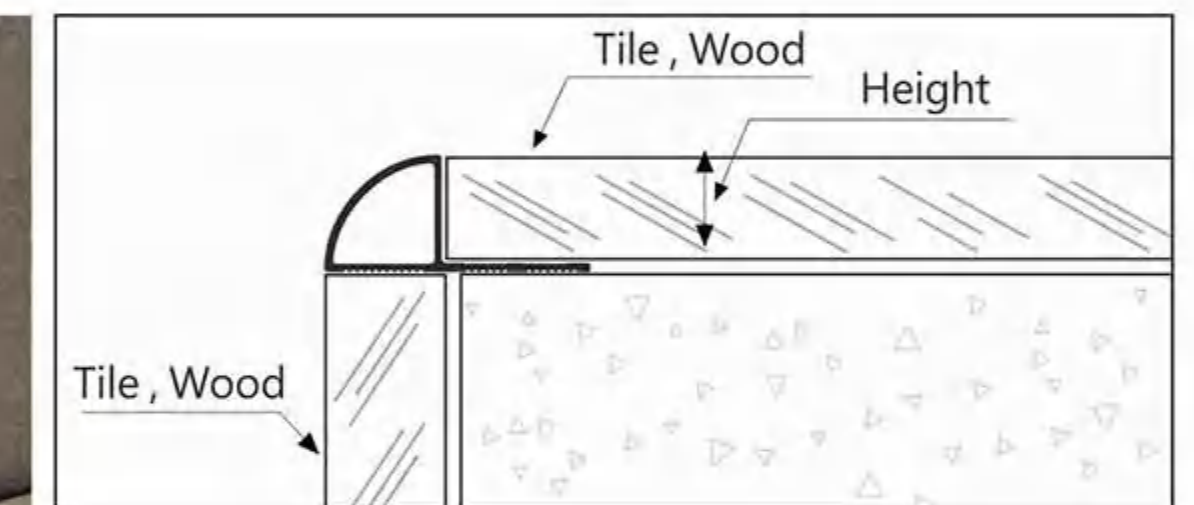

Height	Length	Thickness	Remark
8mm/0.315in	2500~3000mm 8.2ft~9.84ft	1.0~1.2(mm) 0.04~0.047in	Size can be customized.
10mm/0.394in			
12mm/0.472in			



Aluminium tile trim

Tile decorative strips come in a variety of designs and colors, seamlessly blending with different interior styles and enhancing overall beauty.

Aluminium tile trim

Tile decorative strips boast excellent waterproof properties, making them ideal for use in kitchens and bathrooms, effectively preventing mold growth.

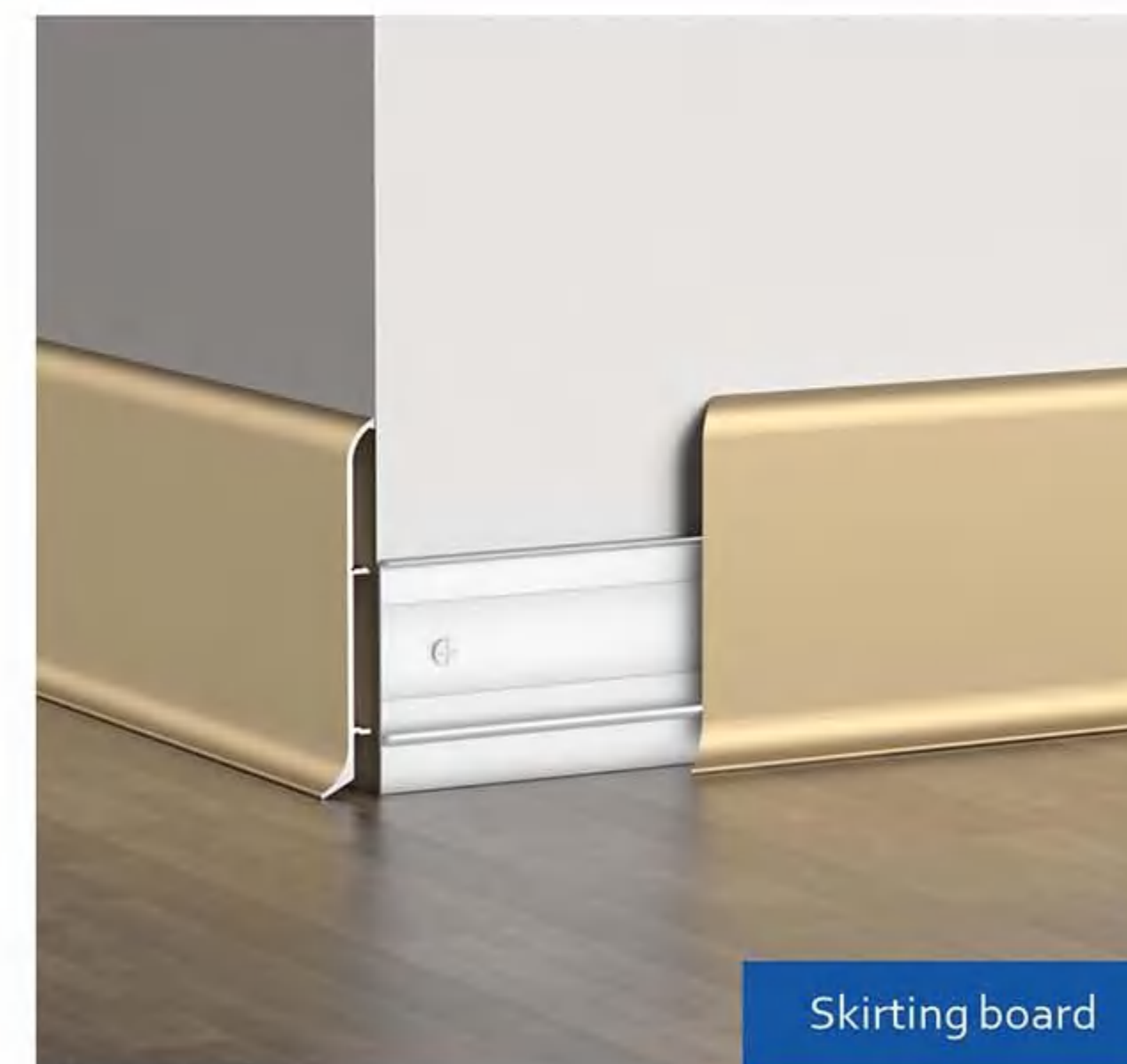
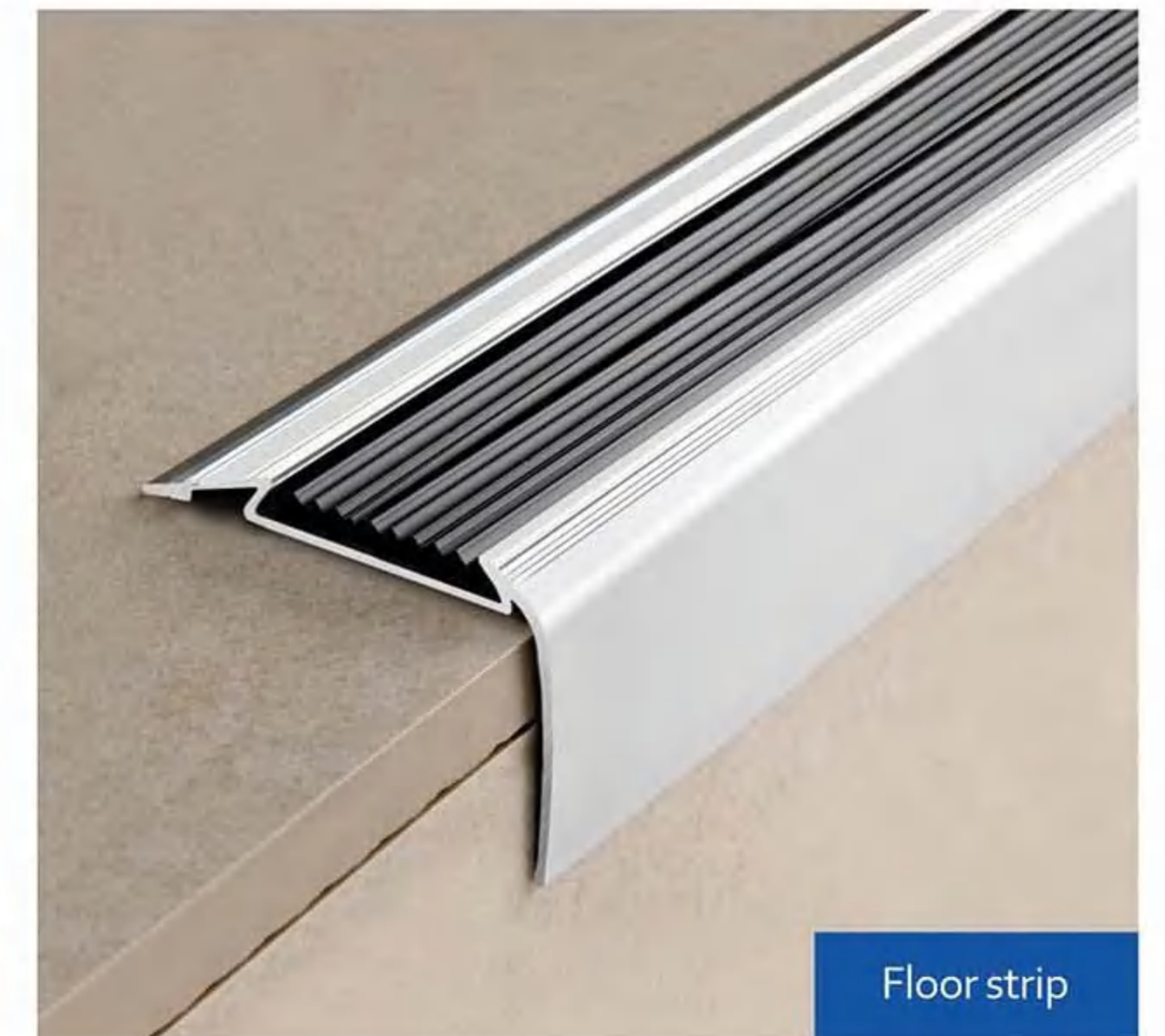
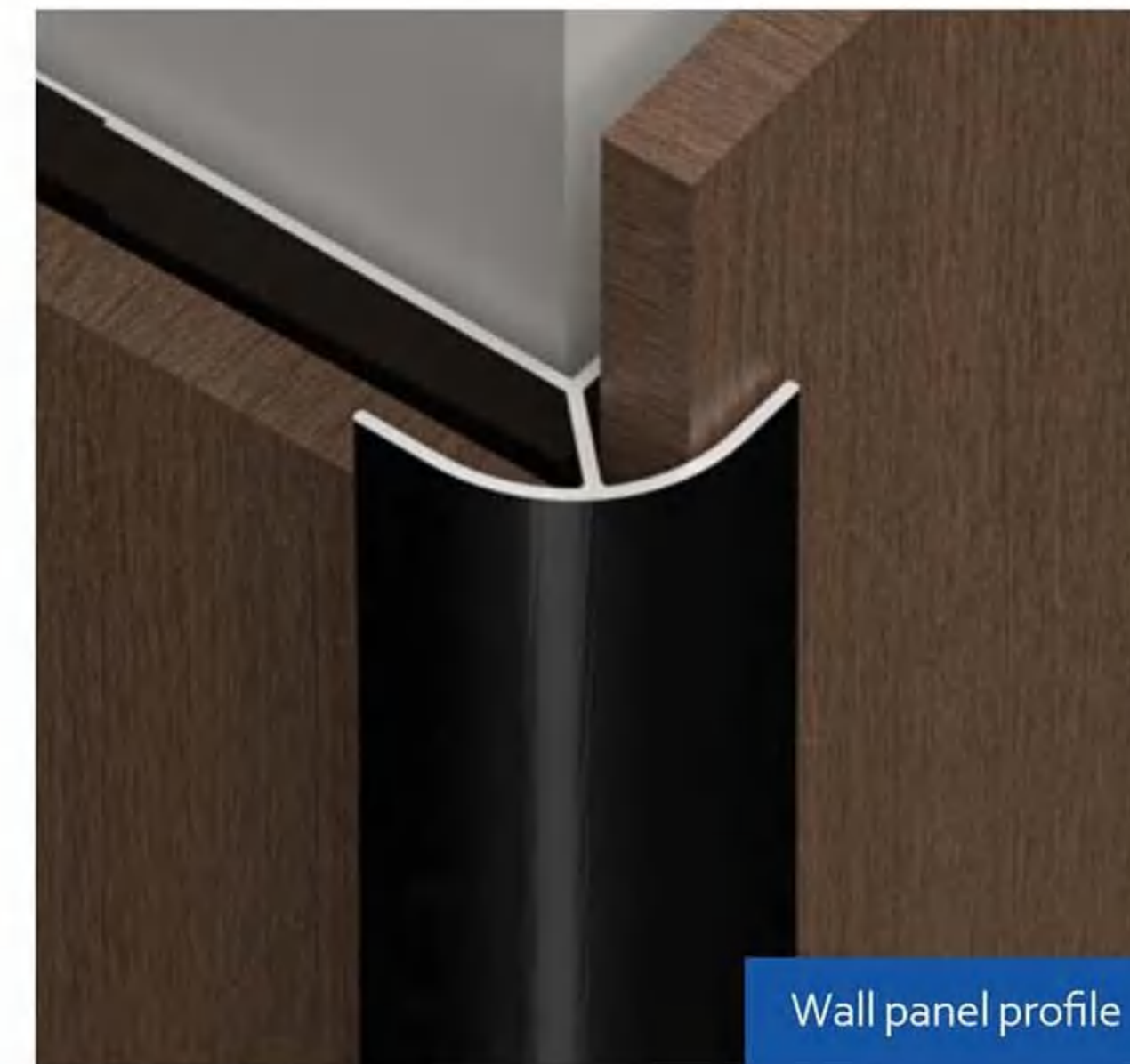
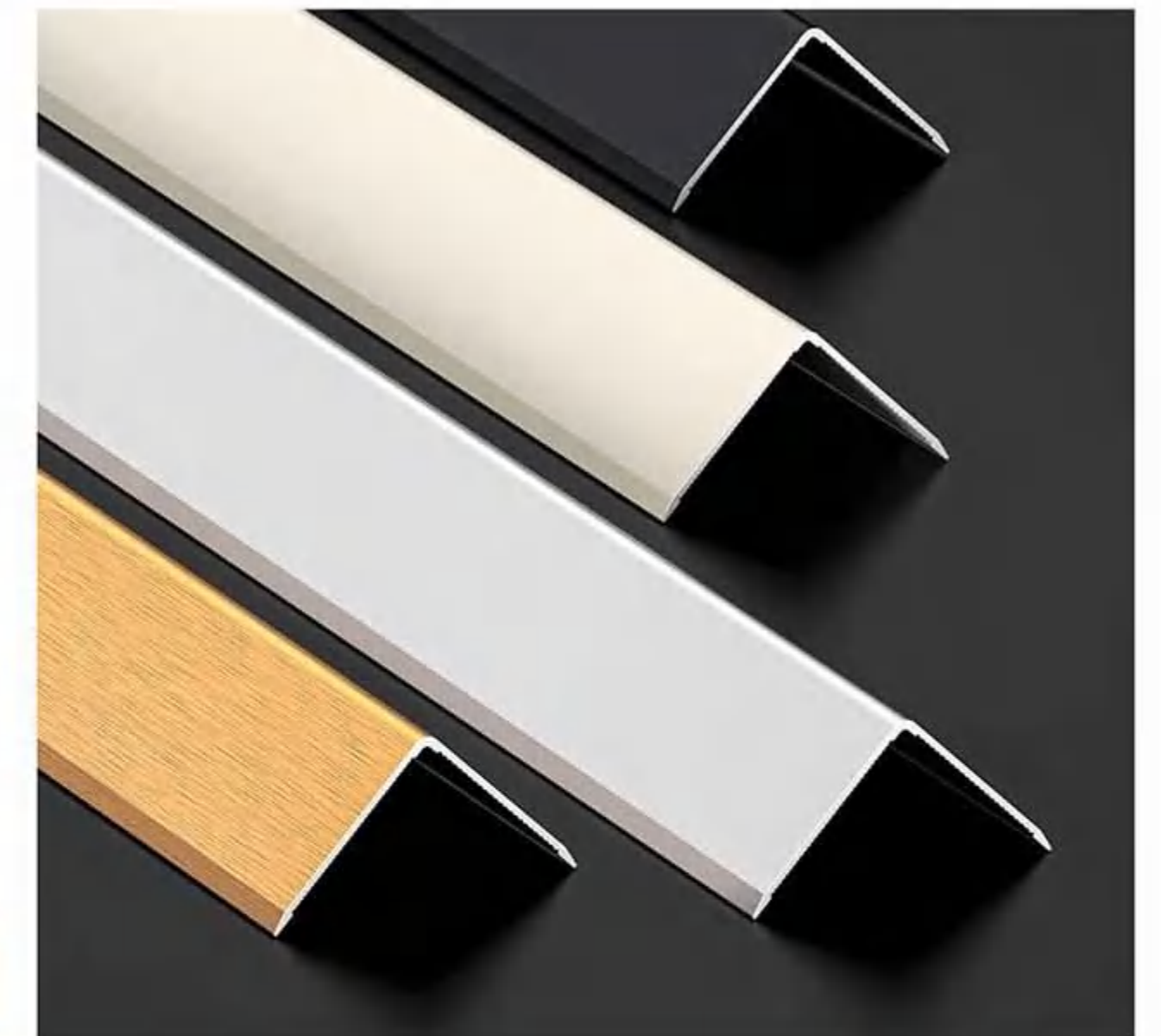
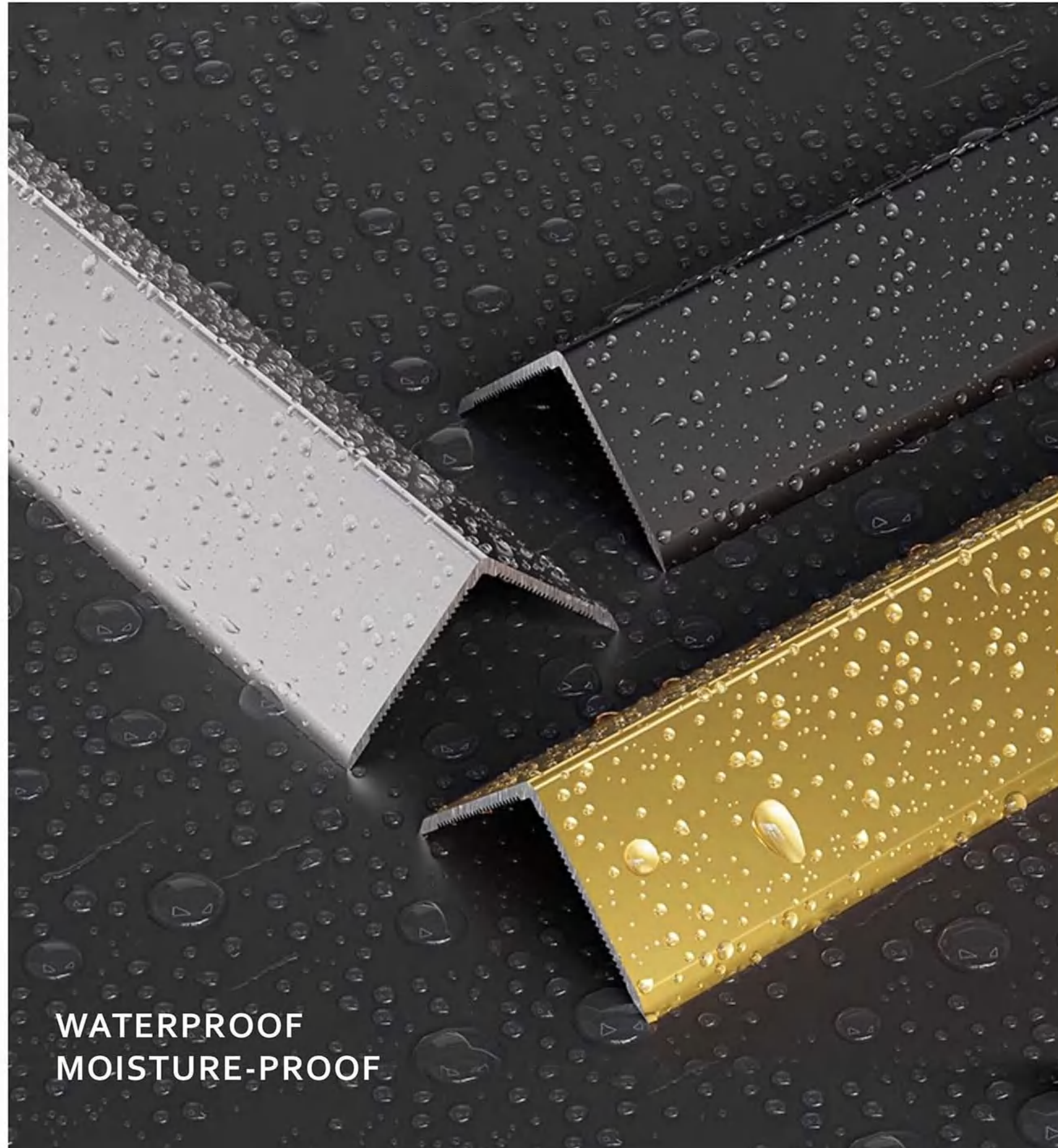

ALUMINIUM TILE TRIM





榕益 ROUYI®
FREE DESIGN AND OEM

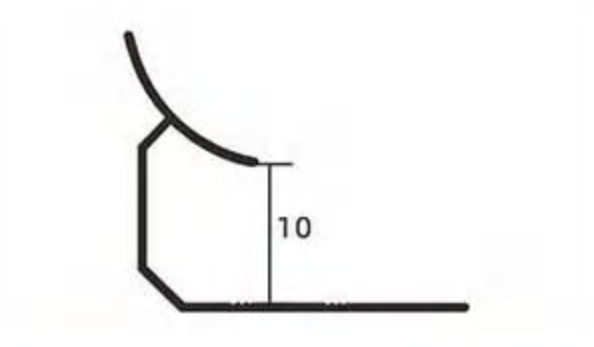
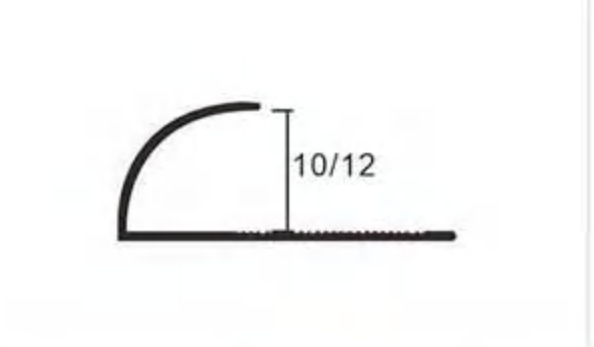
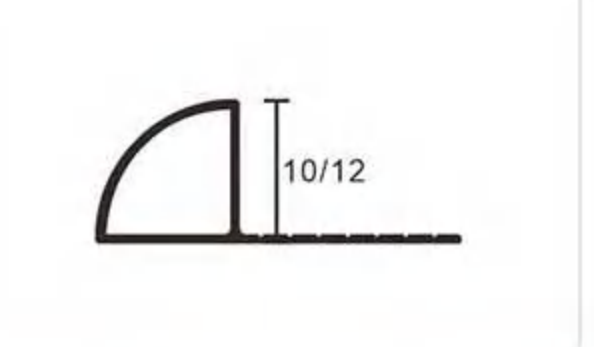
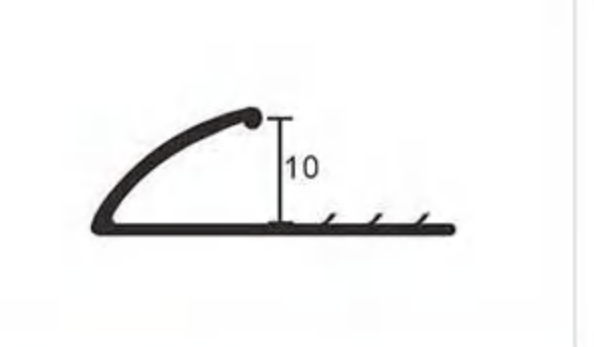
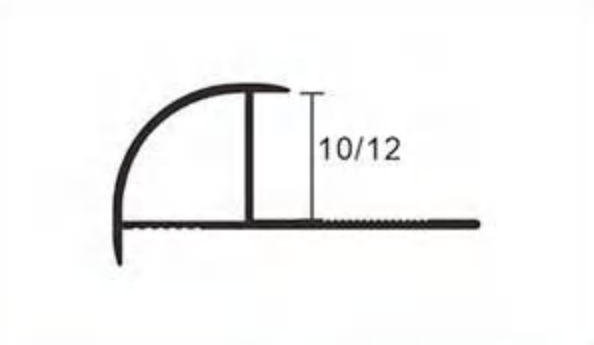
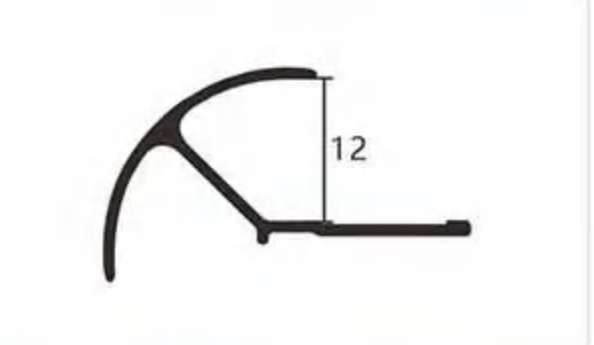
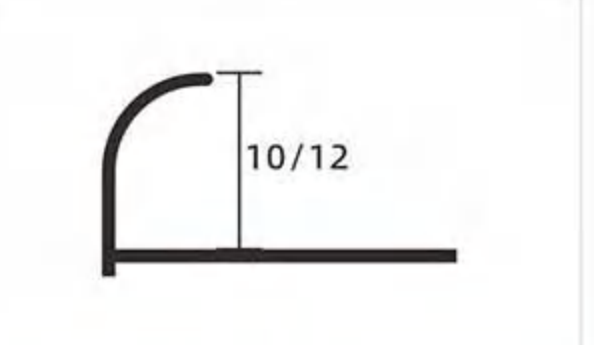
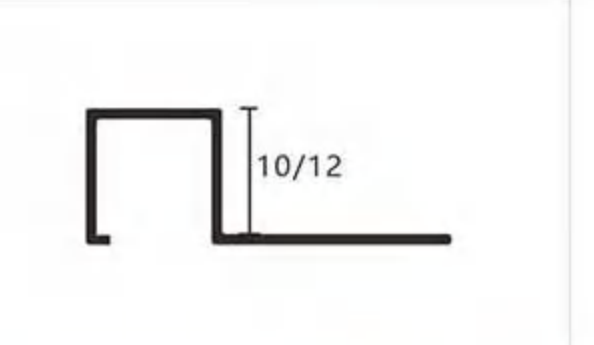
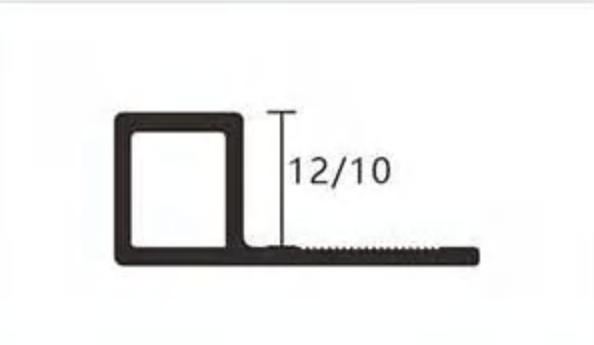
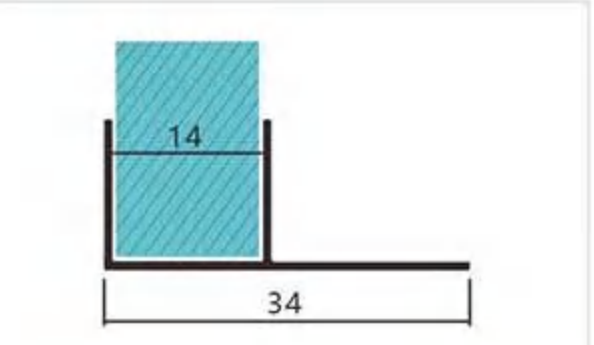
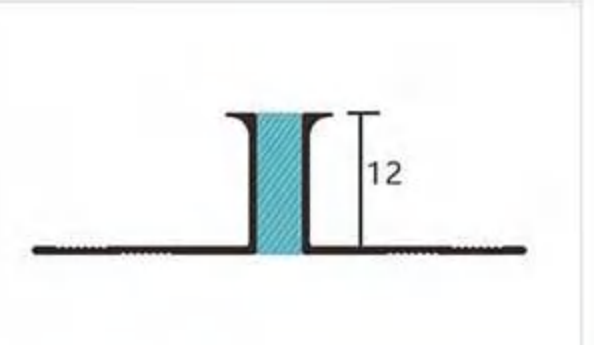
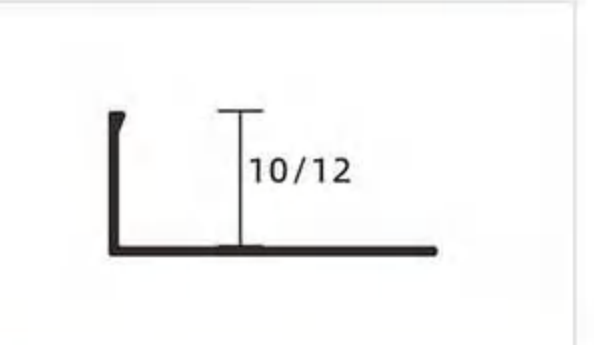

Fashionable and versatile

CAD LINE GRAPH

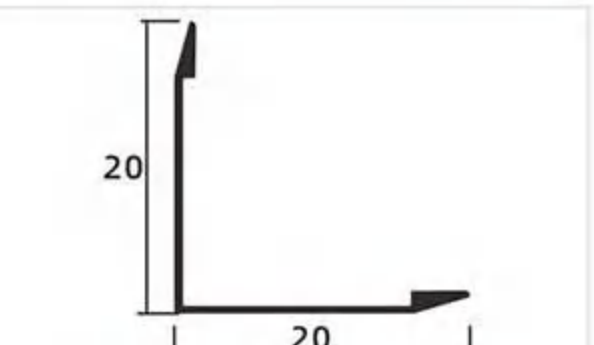
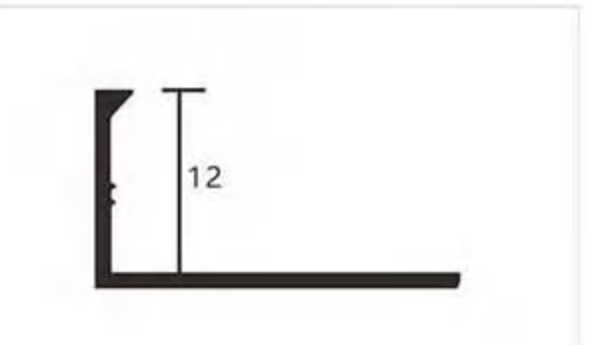
Rongyi Building Materials

			
Inner corner 阴角线	RO10 / RO12 开口款	Round close 圆封口	carpet strip 地毯扣条
			
Round close 圆封口	Open shape 开口款	Open shape 开口款	Square open 方型开口
			
Square model	F-shaped F槽	Expansion joints 拓展条	L-shaped
			
Angle 直角 10*10/20*20 30*30	Angle A 直角款	L-shaped L型款	Wall panel profile 造型线
			
LED light profile 灯槽线			

Open shape

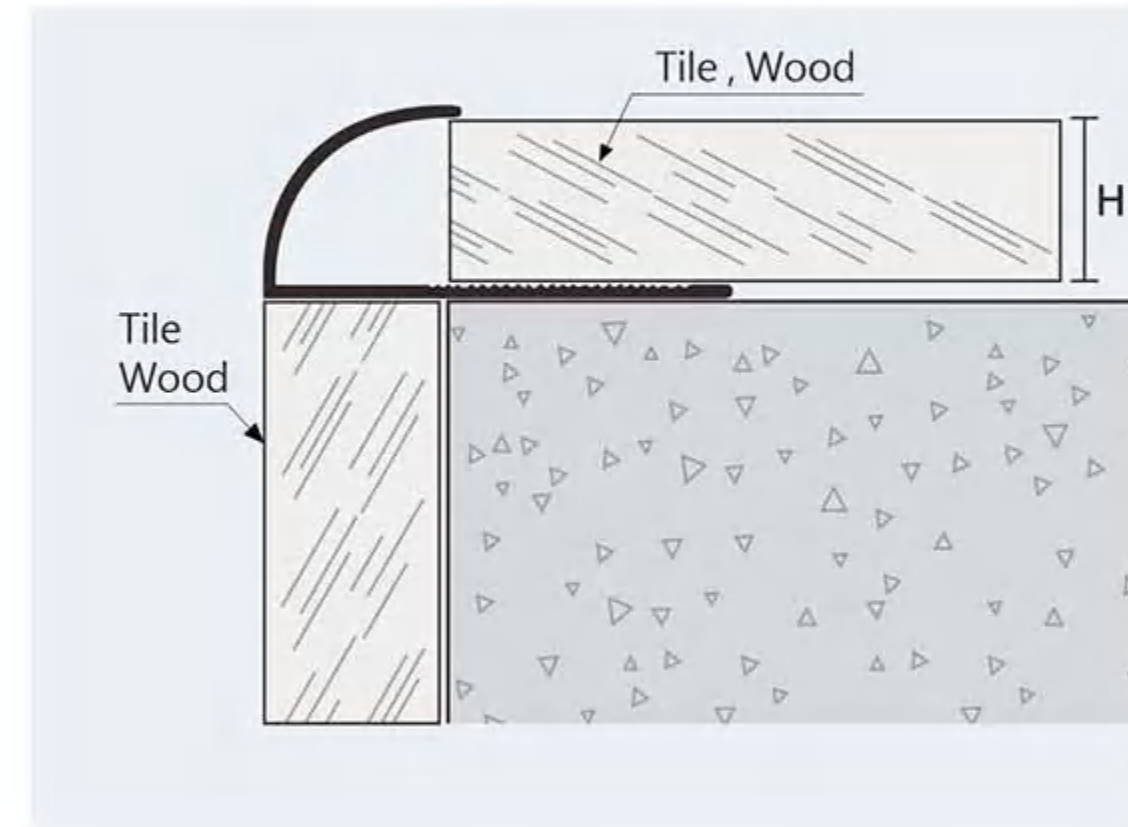
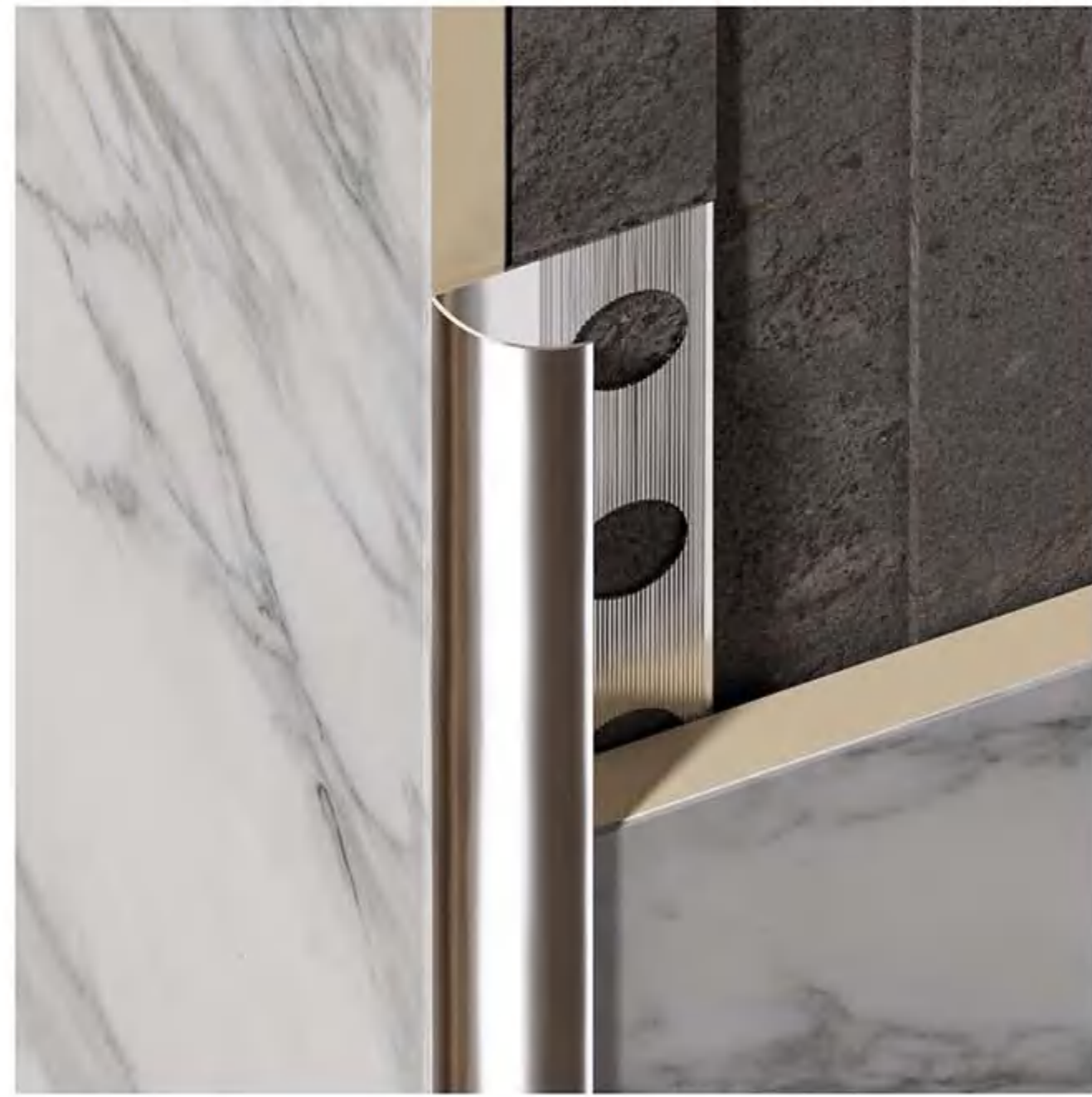

Height	Length	Thickness	Remark
8mm/0.315in	2500~3000mm 8.2ft~9.84ft	0.5~1.0(mm) 0.02~0.04in	Size can be customized.
10mm/0.394in			
12mm/0.472in			

CAD LINE GRAPH

<p>MODEL CKK-04 WEIGHT (kg/m) 0.057</p>	<p>MODEL CKK-10 WEIGHT (kg/m) 0.114</p>	<p>MODEL CKK-15 WEIGHT (kg/m) 0.051</p>	<p>MODEL CKK-18 WEIGHT (kg/m) 0.120</p>
<p>MODEL CKK-20 WEIGHT (kg/m) 0.065</p>	<p>MODEL CKK-21 WEIGHT (kg/m) 0.100</p>	<p>MODEL CKK-33 WEIGHT (kg/m) 0.126</p>	<p>MODEL CKK-45 WEIGHT (kg/m) 0.099</p>



Round close



Height	Length	Thickness	Remark
8mm/0.315in	2500~3000mm 8.2ft~9.84ft	0.5~1.0(mm) 0.02~0.04in	Size can be customized.
10mm/0.394in			
12mm/0.472in			

CAD LINE GRAPH

MODEL CBK-48 WEIGHT (kg/m) 0.099	MODEL CBK-52 WEIGHT (kg/m) 0.098	MODEL CBK-58 WEIGHT (kg/m) 0.137	MODEL CBK-61 WEIGHT (kg/m) 0.184
MODEL CBK-68 WEIGHT (kg/m) 0.160	MODEL CBK-71 WEIGHT (kg/m) 0.090	MODEL CBK-73 WEIGHT (kg/m) 0.144	MODEL CBK-77 WEIGHT (kg/m) 0.151

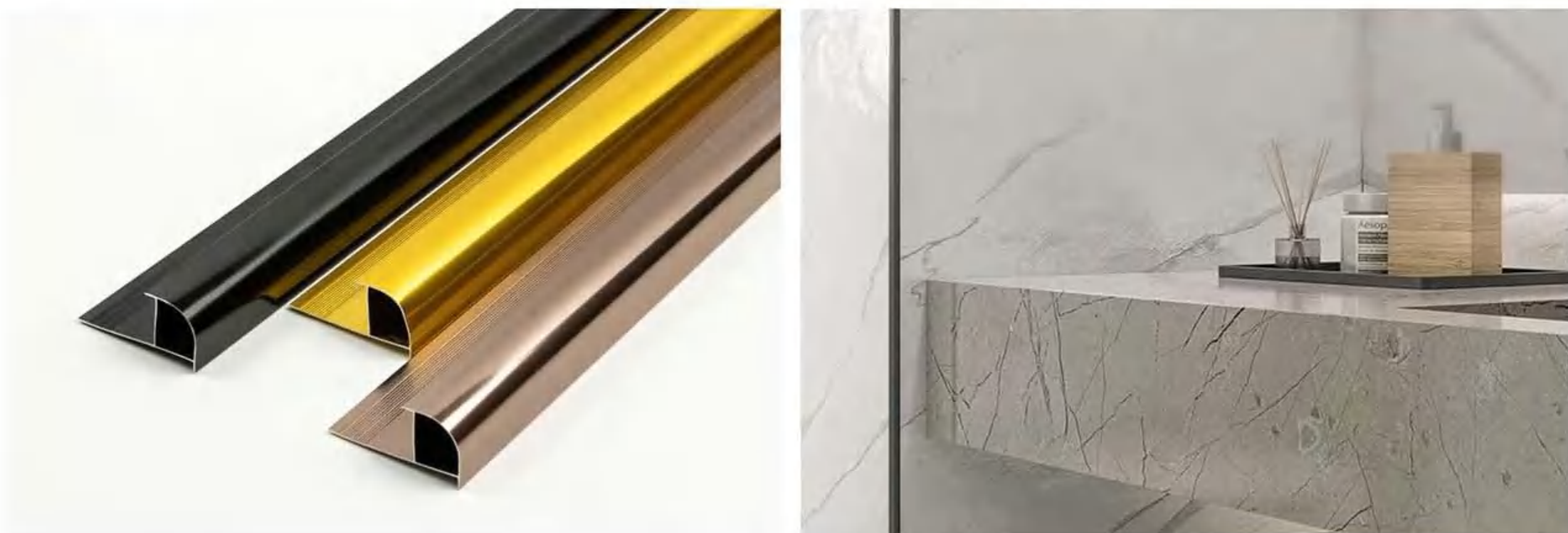

ASSEMBLY DRAWING



Height	Length	Thickness	Remark
8mm/0.315in	2500~3000mm 8.2ft~9.84ft	0.5~1.0(mm) 0.02~0.04in	Size can be customized.
10mm/0.394in			
12mm/0.472in			

CAD LINE GRAPH

Round close 圓封口	MODEL CBK-52 WEIGHT (kg/m) 0.098	MODEL CBK-58 WEIGHT (kg/m) 0.137	MODEL CBK-61 WEIGHT (kg/m) 0.184



U-shaped

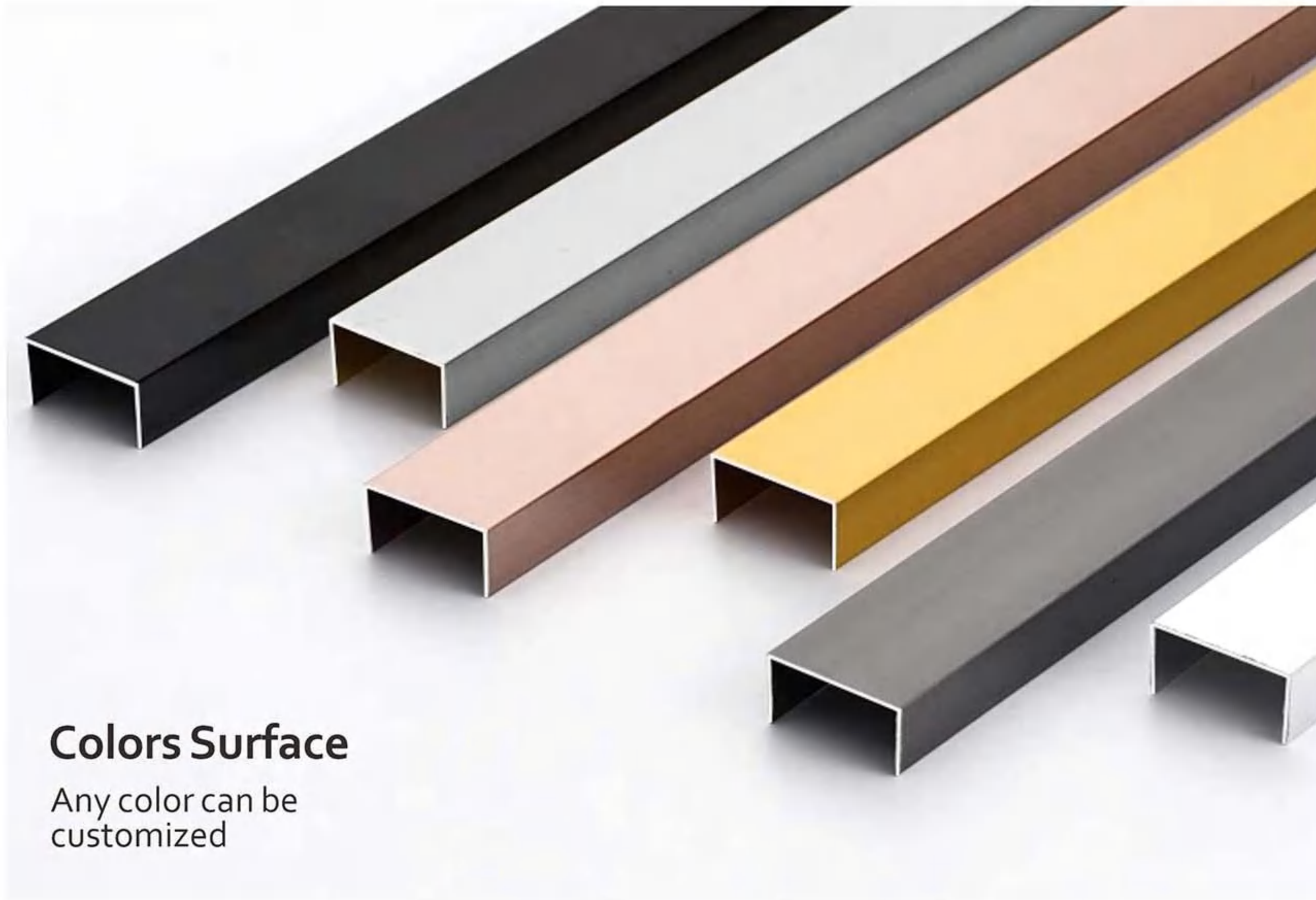

Colors Surface
Any color can be customized

ASSEMBLY DRAWING

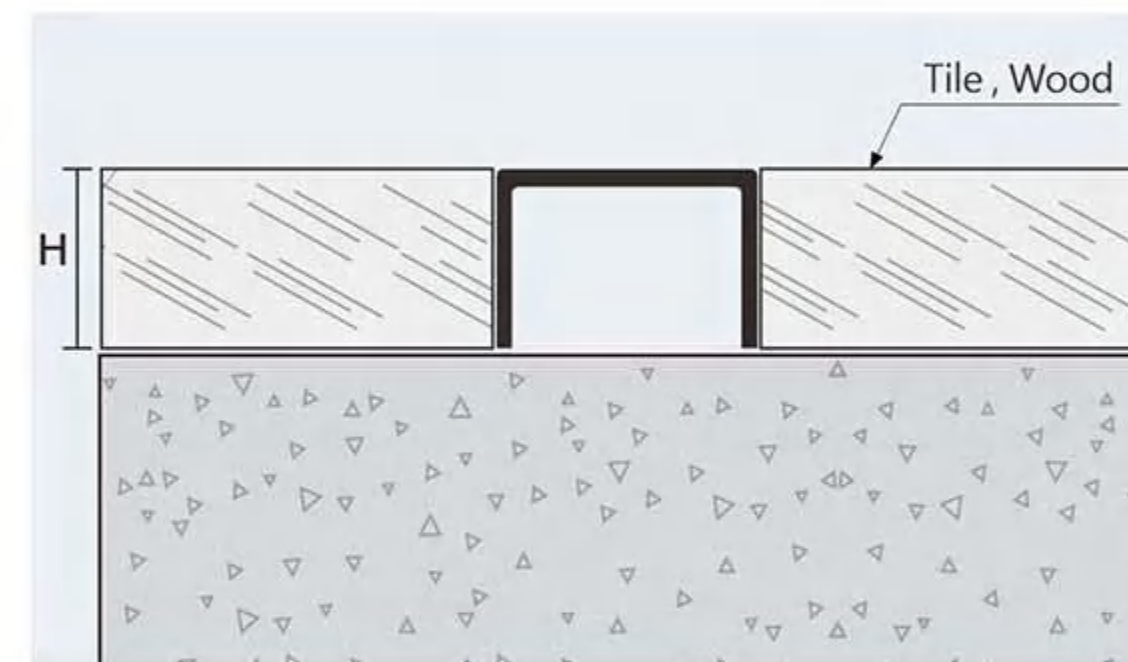

Size	Length	Thickness	Remark
10*10*10mm	2500~3000mm 8.2ft~9.84ft	0.5~1.0(mm) 0.02~0.04in	Size can be customized.
10*15*10mm			
10*20*10mm			
10*25*10mm			
10*30*10mm			

CAD LINE GRAPH

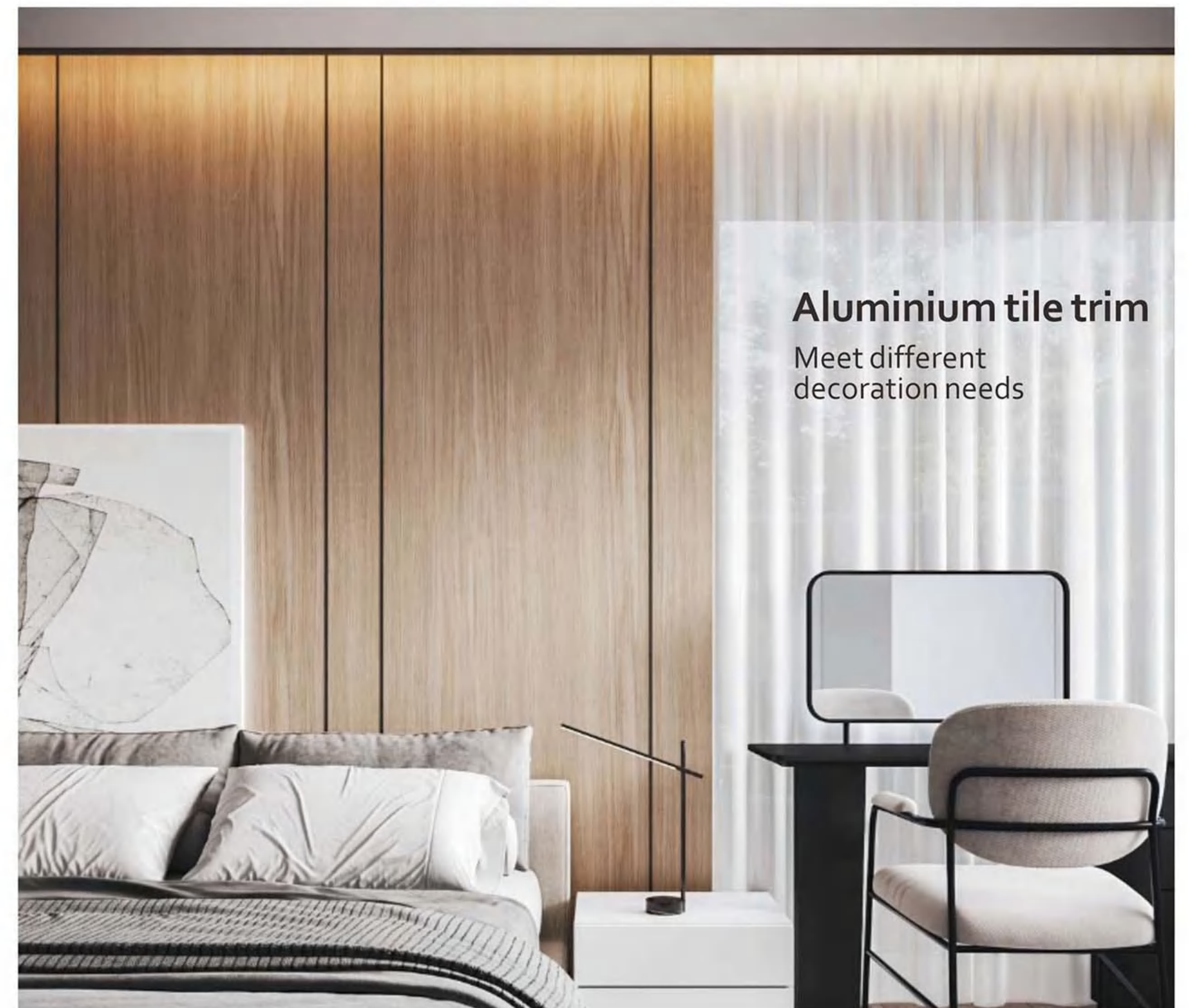
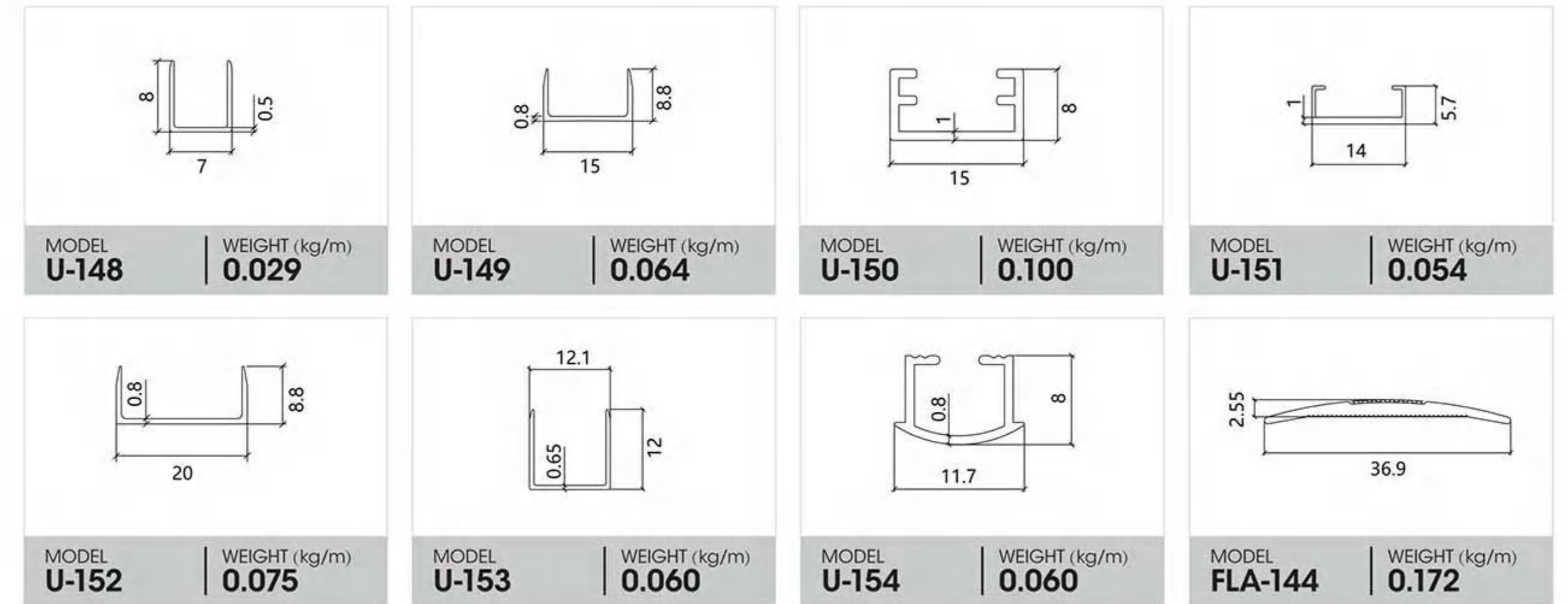

Square open



Height	Length	Thickness	Remark
8mm/0.315in	2500~3000mm 8.2ft~9.84ft	0.5~1.0(mm) 0.02~0.04in	Size can be customized.
10mm/0.394in			
12mm/0.472in			



CAD LINE GRAPH

<p>MODEL SQ-117 WEIGHT (kg/m) 0.163</p>	<p>MODEL SQ-118 WEIGHT (kg/m) 0.143</p>	<p>MODEL SQ-119 WEIGHT (kg/m) 0.123</p>	<p>MODEL SQ-120 WEIGHT (kg/m) 0.206</p>
<p>MODEL SQ-121 WEIGHT (kg/m) 0.151</p>	<p>MODEL SQ-122 WEIGHT (kg/m) 0.167</p>	<p>MODEL SQ-123 WEIGHT (kg/m) 0.115</p>	<p>MODEL KB-130 WEIGHT (kg/m) 0.037</p>
<p>MODEL KB-137 WEIGHT (kg/m) 0.112</p>	<p>MODEL KB-140 WEIGHT (kg/m) 0.100</p>	<p>MODEL KB-142 WEIGHT (kg/m) 0.061</p>	<p>MODEL BOSQ12 WEIGHT (kg/m) 0.08</p>



Angle

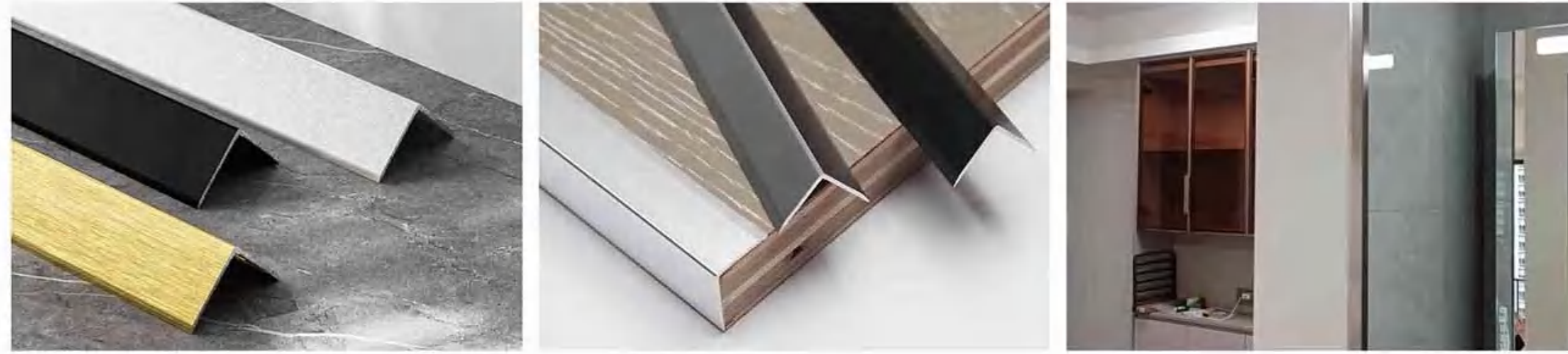

CAD LINE GRAPH

<p>MODEL L-85 WEIGHT (kg/m) 0.114</p>	<p>MODEL L-91 WEIGHT (kg/m) 0.081</p>	<p>MODEL L-96 WEIGHT (kg/m) 0.068</p>	<p>MODEL L-103 WEIGHT (kg/m) 0.068</p>
<p>MODEL L-104 WEIGHT (kg/m) 0.072</p>	<p>MODEL L-108 WEIGHT (kg/m) 0.082</p>	<p>MODEL L-110 WEIGHT (kg/m) 0.180</p>	<p>MODEL L-116 WEIGHT (kg/m) 0.074</p>

ASSEMBLY DRAWING



Height	Length	Thickness	Remark
8mm/0.315in			
10mm/0.394in	2500~3000mm 8.2ft~9.84ft	0.5~1.0(mm) 0.02~0.04in	Size can be customized.
12mm/0.472in			

ASSEMBLY DRAWING

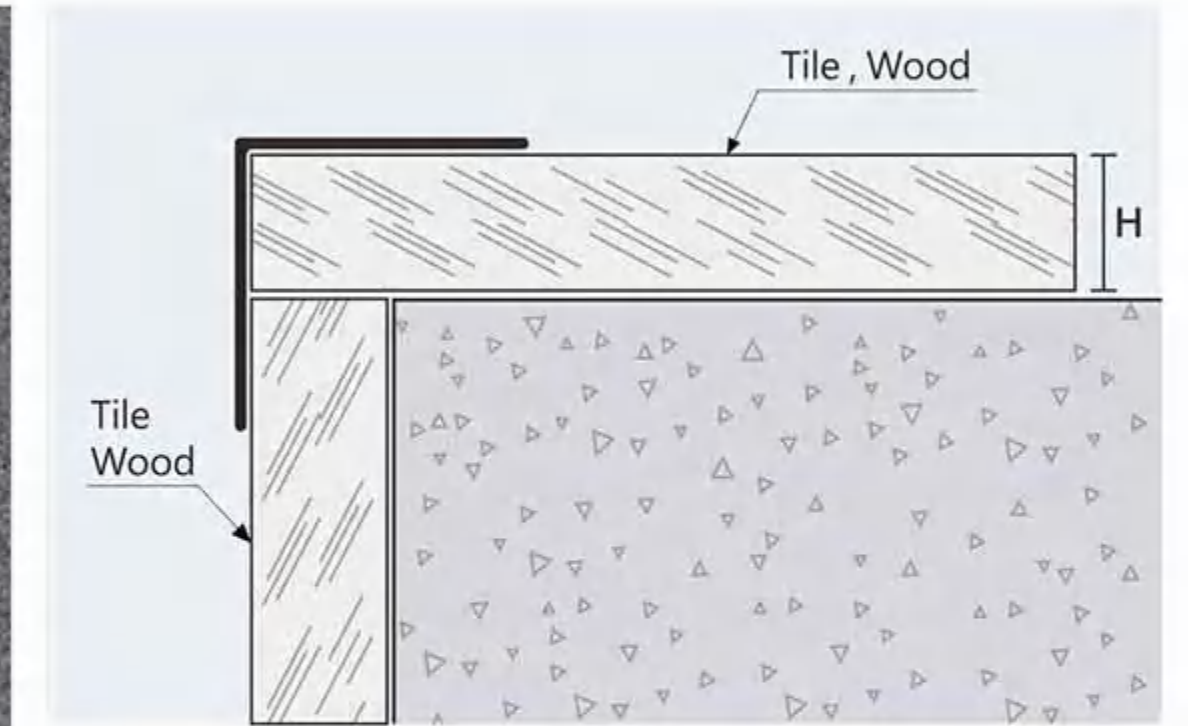

Height	Length	Thickness	Remark
10mm/0.394in			
15mm/0.591in	2500~3000mm 8.2ft~9.84ft	0.5~1.0(mm) 0.02~0.04in	Size can be customized.
20mm/0.787in			
25mm/0.984in			
30mm/1.181in			

CAD LINE GRAPH

<p>MODEL COR-245 WEIGHT (kg/m) 0.048</p>	<p>MODEL COR-258 WEIGHT (kg/m) 0.114</p>	<p>MODEL COR-247 WEIGHT (kg/m) 0.061</p>	<p>MODEL COR-265 WEIGHT (kg/m) 0.049</p>
<p>MODEL COR-270 WEIGHT (kg/m) 0.118</p>	<p>MODEL COR-267 WEIGHT (kg/m) 0.062</p>	<p>MODEL COR-272 WEIGHT (kg/m) 0.060</p>	<p>MODEL COR-276 WEIGHT (kg/m) 0.046</p>
<p>MODEL COR-282 WEIGHT (kg/m) 0.040</p>	<p>MODEL COR-283 WEIGHT (kg/m) 0.064</p>	<p>MODEL COR-284 WEIGHT (kg/m) 0.085</p>	<p>MODEL COR-285 WEIGHT (kg/m) 0.160</p>

T-shaped

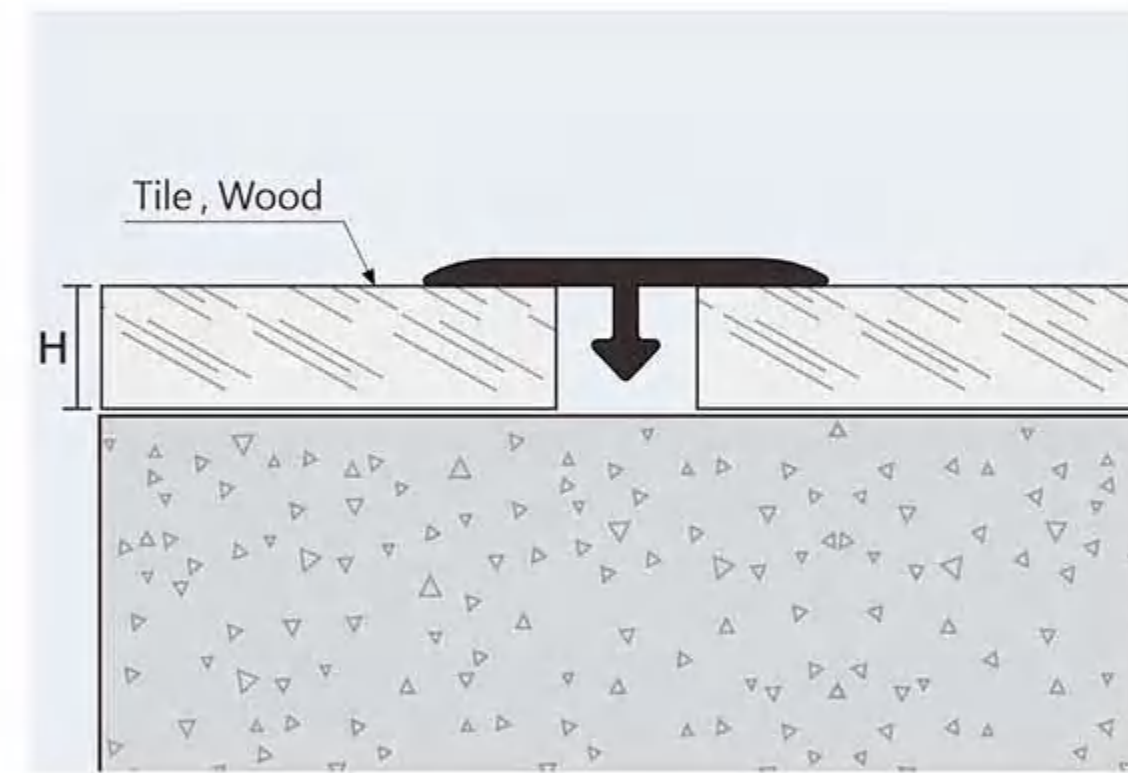
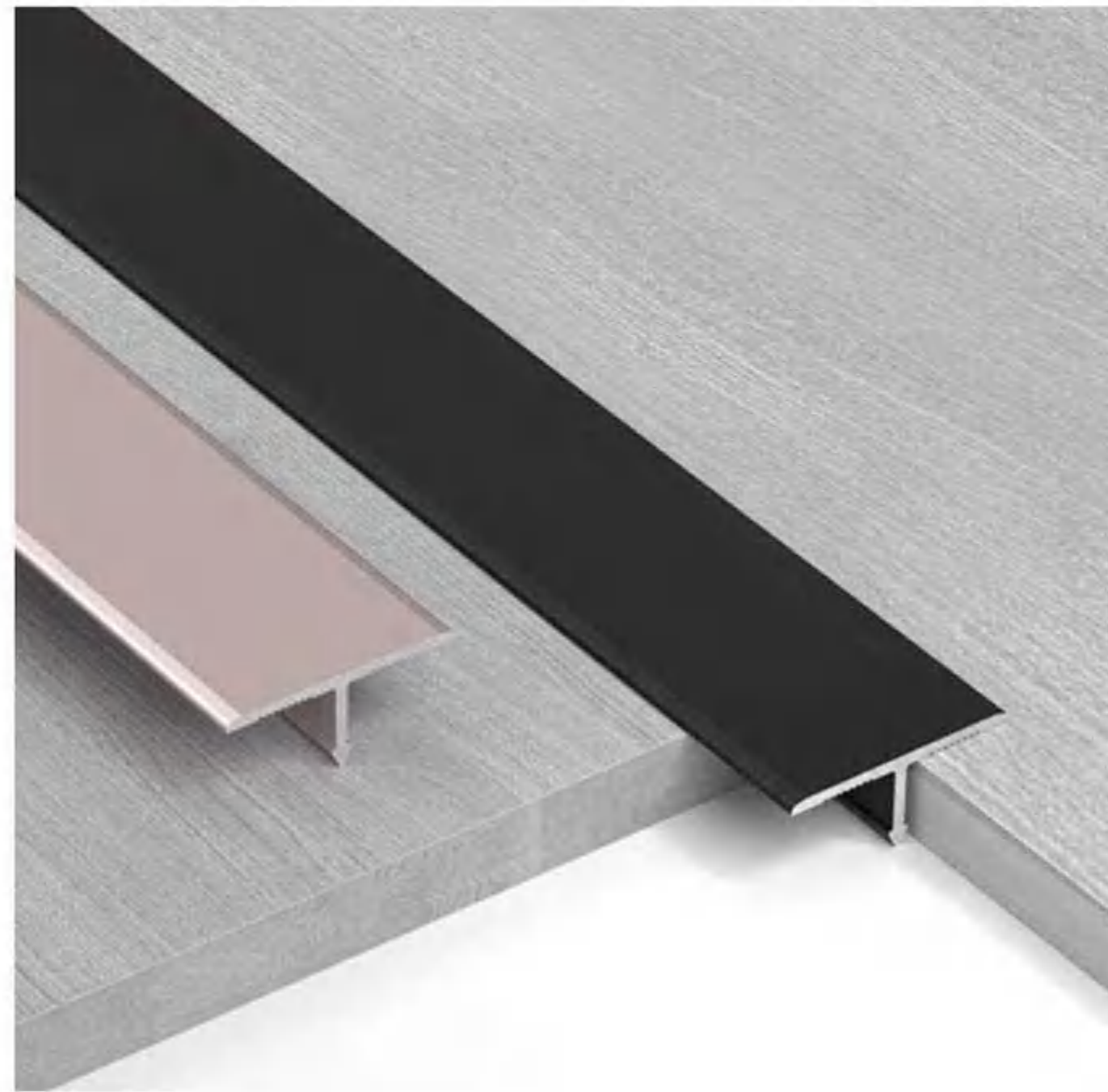

Width	Length	Thickness	Remark
10mm/0.394in	2500~3000mm 8.2ft~9.84ft	0.5~1.0(mm) 0.02~0.04in	Size can be customized.
15mm/0.591in			
20mm/0.787in			
25mm/0.984in			
30mm/1.181in			

CAD LINE GRAPH

ALUMINIUM | ROUND CLOSE

MODEL T-175 WEIGHT (kg/m) 0.061	MODEL T-176 WEIGHT (kg/m) 0.018	MODEL T-178 WEIGHT (kg/m) 0.078	MODEL T-180 WEIGHT (kg/m) 0.110
MODEL T-181 WEIGHT (kg/m) 0.130	MODEL T-185 WEIGHT (kg/m) 0.183	MODEL T-191 WEIGHT (kg/m) 0.060	MODEL T-193 WEIGHT (kg/m) 0.090
MODEL T-195 WEIGHT (kg/m) 0.080	MODEL T-198 WEIGHT (kg/m) 0.021	MODEL TT-200 WEIGHT (kg/m) 0.033	MODEL T-201 WEIGHT (kg/m) 0.033

Floor press

ASSEMBLY DRAWING

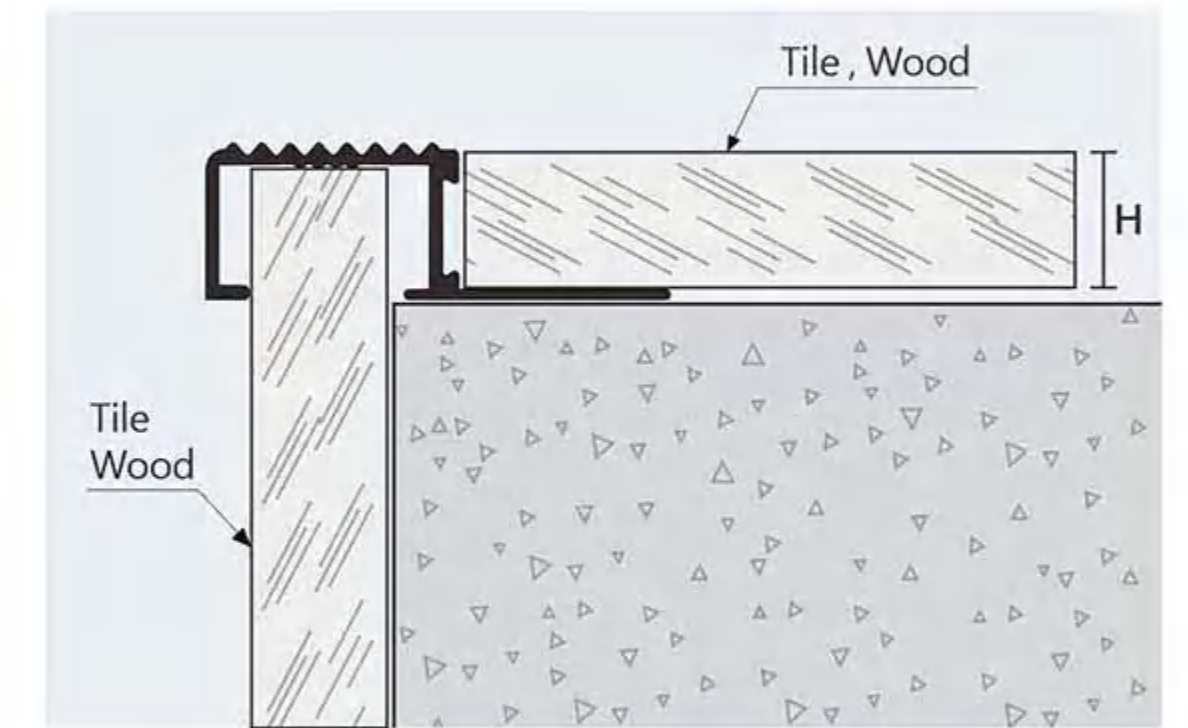

Height	Length	Thickness	Remark
8mm/0.315in	2500~3000mm 8.2ft~9.84ft	0.5~1.0(mm) 0.02~0.04in	Size can be customized.
10mm/0.394in			
12mm/0.472in			

CAD LINE GRAPH

MODEL STA-290 WEIGHT (kg/m) 0.166	MODEL STA-291 WEIGHT (kg/m) 0.128	MODEL STA-292 WEIGHT (kg/m) 0.213	MODEL STA-293 WEIGHT (kg/m) 0.146
MODEL STA-294 WEIGHT (kg/m) 0.231	MODEL STA-295 WEIGHT (kg/m) 0.172	MODEL STA-296 WEIGHT (kg/m) 0.135	MODEL STA-297 WEIGHT (kg/m) 0.162
MODEL STA-298 WEIGHT (kg/m) 0.133	MODEL STA-299 WEIGHT (kg/m) 0.156	MODEL STA-300 WEIGHT (kg/m) 0.165	MODEL STA-301 WEIGHT (kg/m) 0.175

Floor strip



ASSEMBLY DRAWING

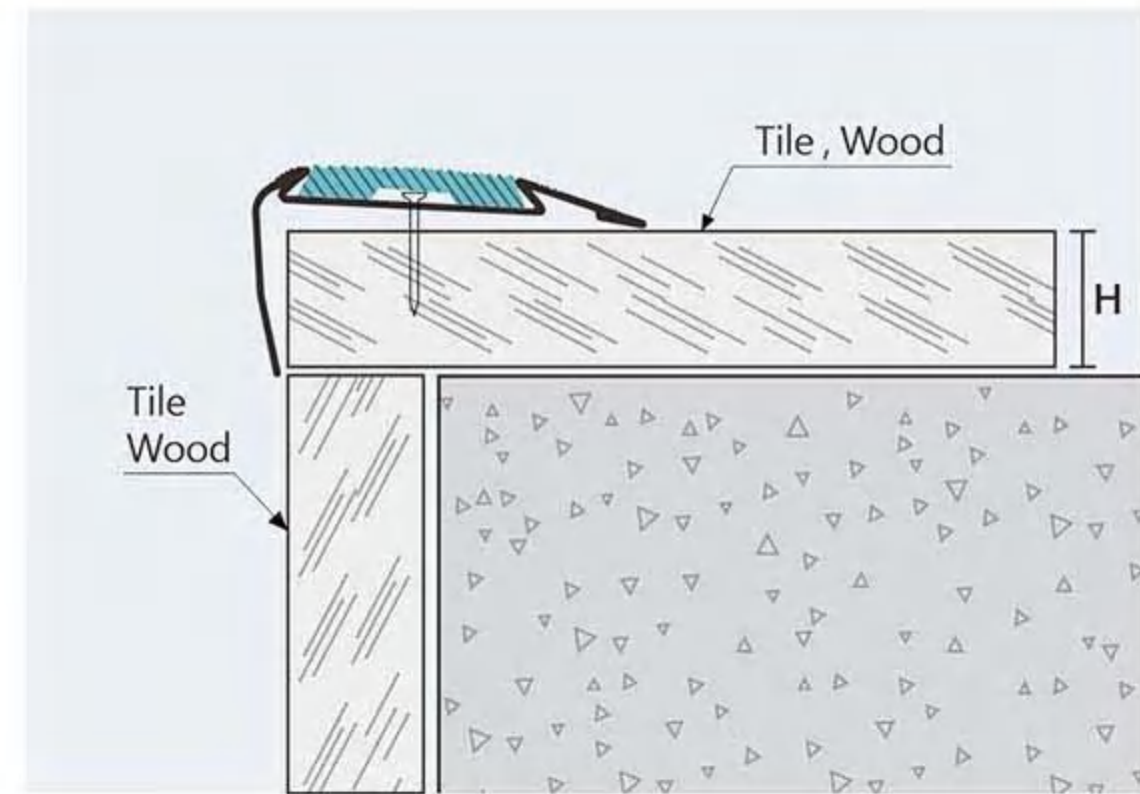

Height	Length	Thickness	Remark
8mm/0.315in	2500~3000mm 8.2ft~9.84ft	0.5~1.0(mm) 0.02~0.04in	Size can be customized.
10mm/0.394in			
12mm/0.472in			

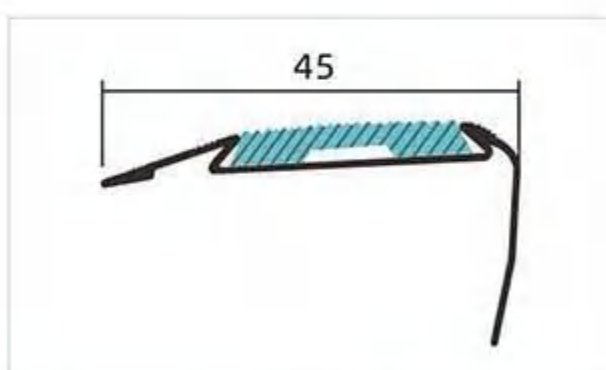

Floor strip A | 直角地板压条

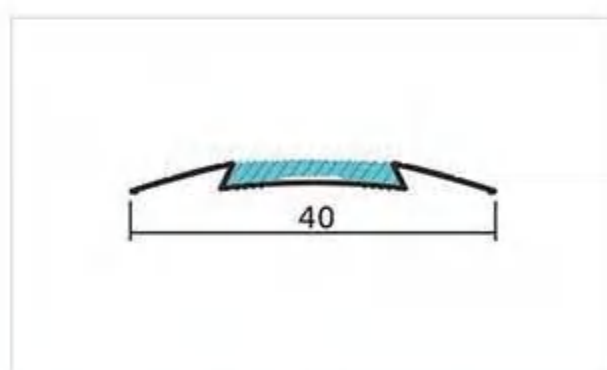

Floor strip B | 地板压条

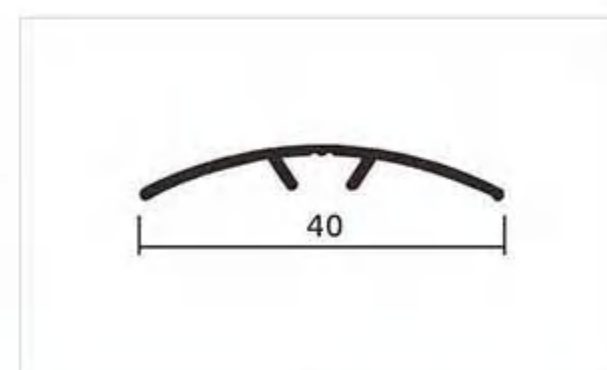

Floor press C | 压条

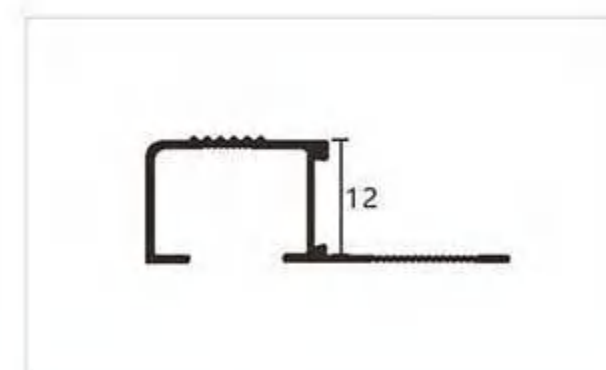

Floor press

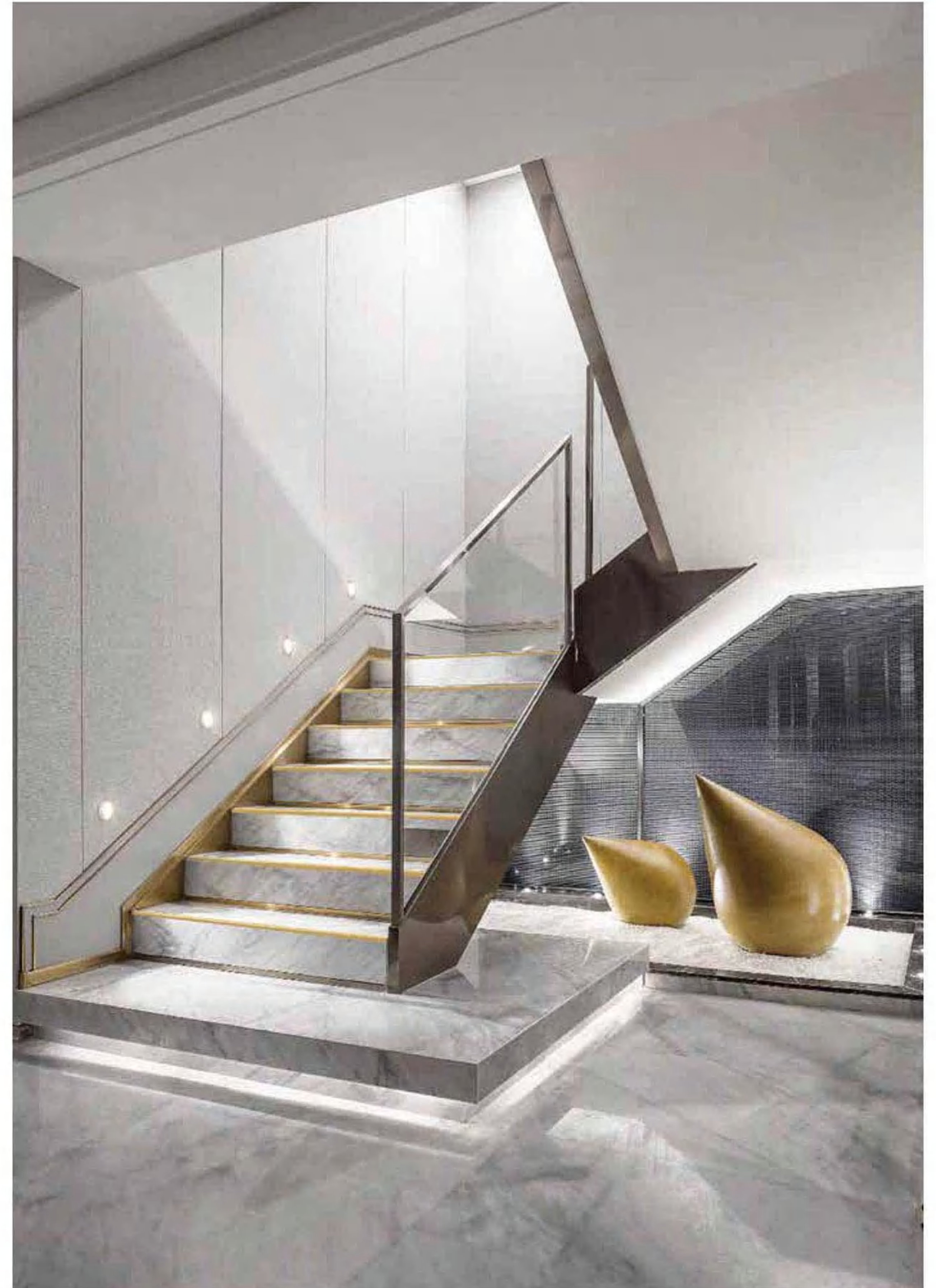

Carpet strip



Height	Length	Thickness	Remark
8mm	2440mm	0.6,0.8,1.0(mm)	Sizes can be customized.
10mm	2440mm	0.6,0.8,1.0(mm)	
12mm	2440mm	0.6,0.8,1.0(mm)	

ASSEMBLY DRAWING

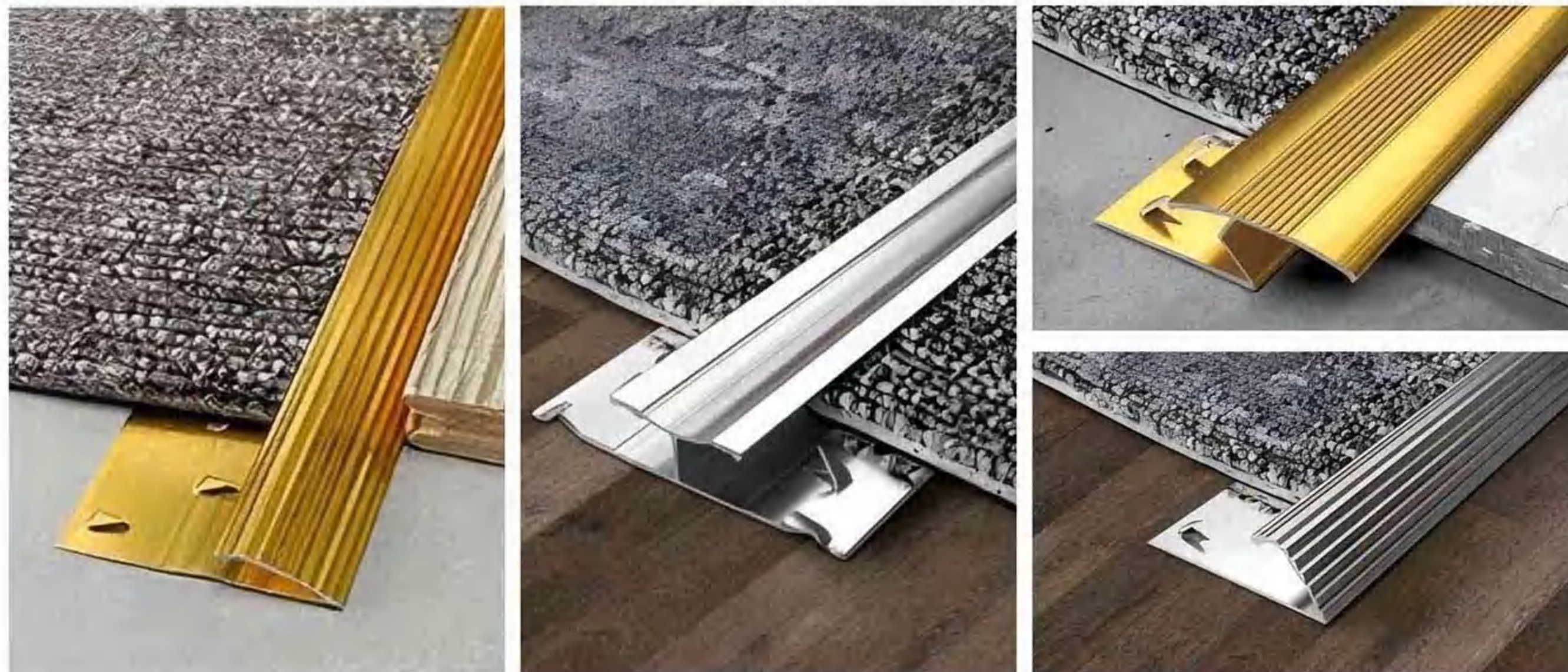

CAD LINE GRAPH

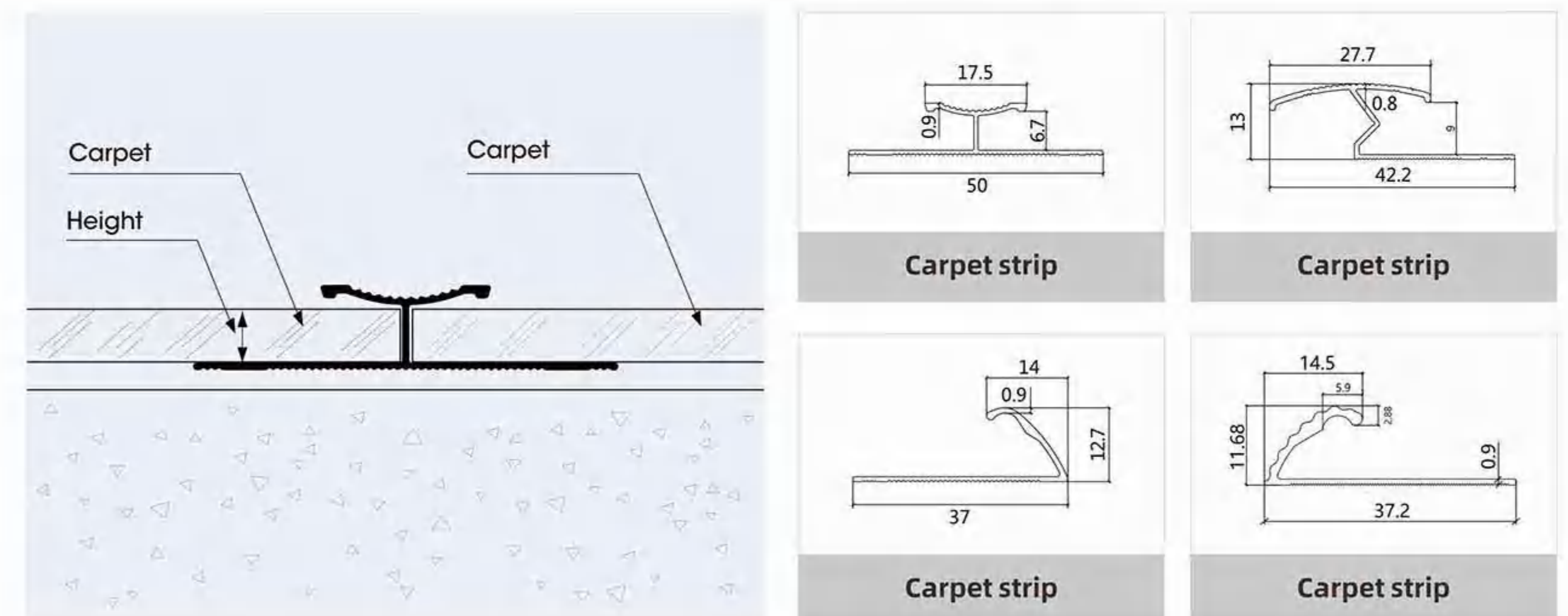



Stainless steel tile trim

Tile decorative strips come in a variety of designs and colors, seamlessly blending with different interior styles and enhancing overall beauty.

Stainless steel tile trim

Free design and OEM

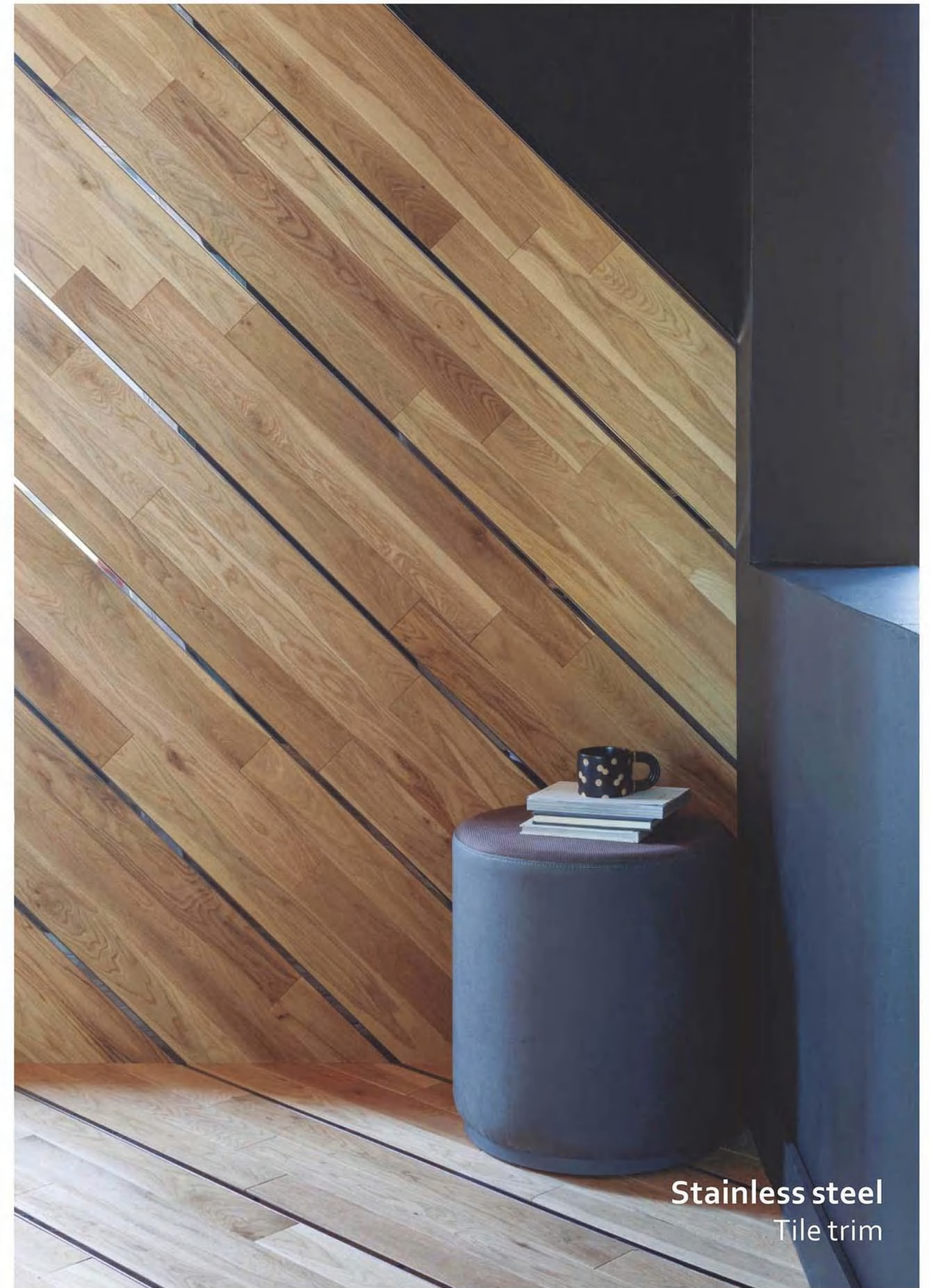
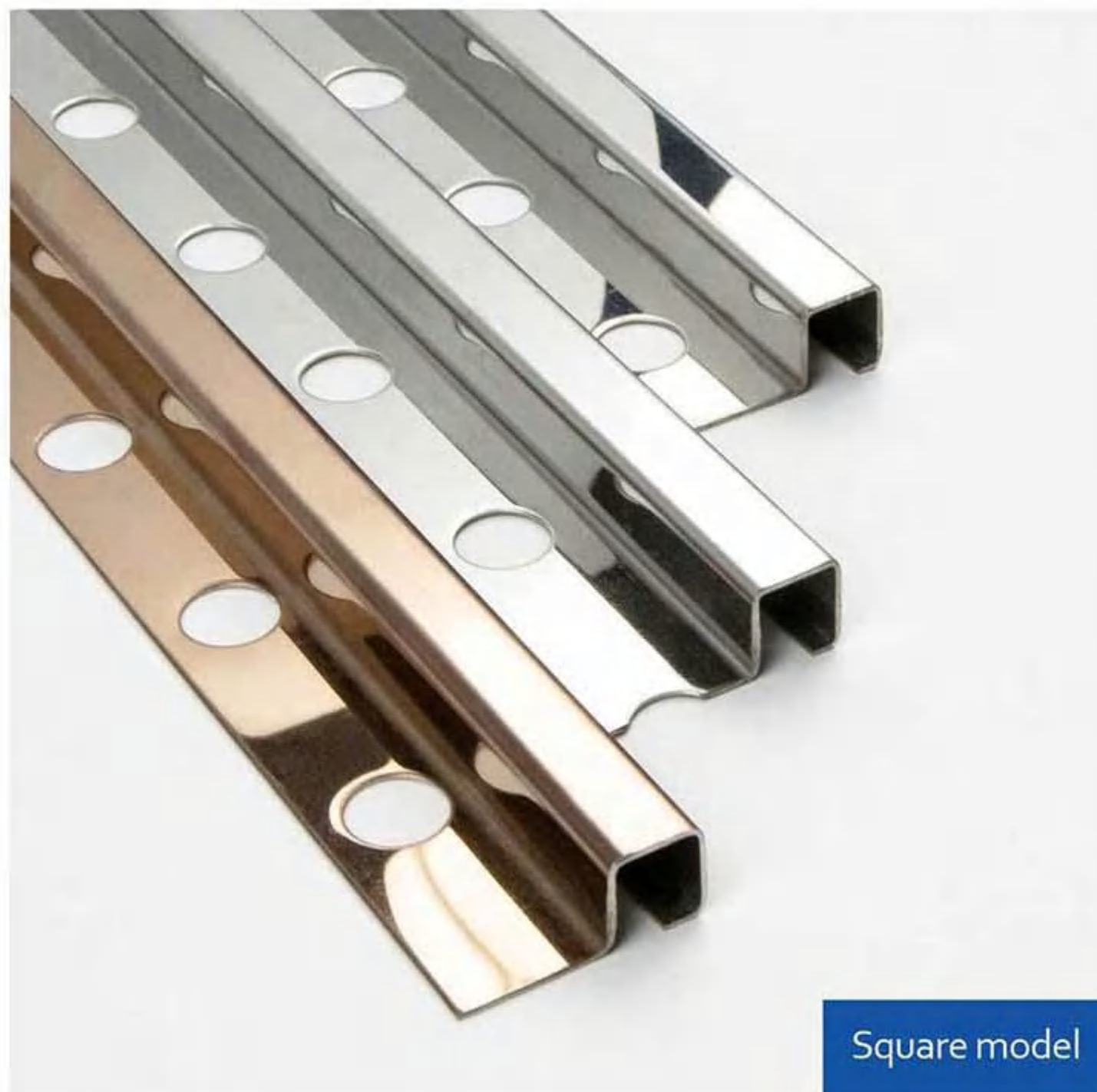

STAINLESS STEEL TILE TRIM



Colors Surface

Any color can be customized

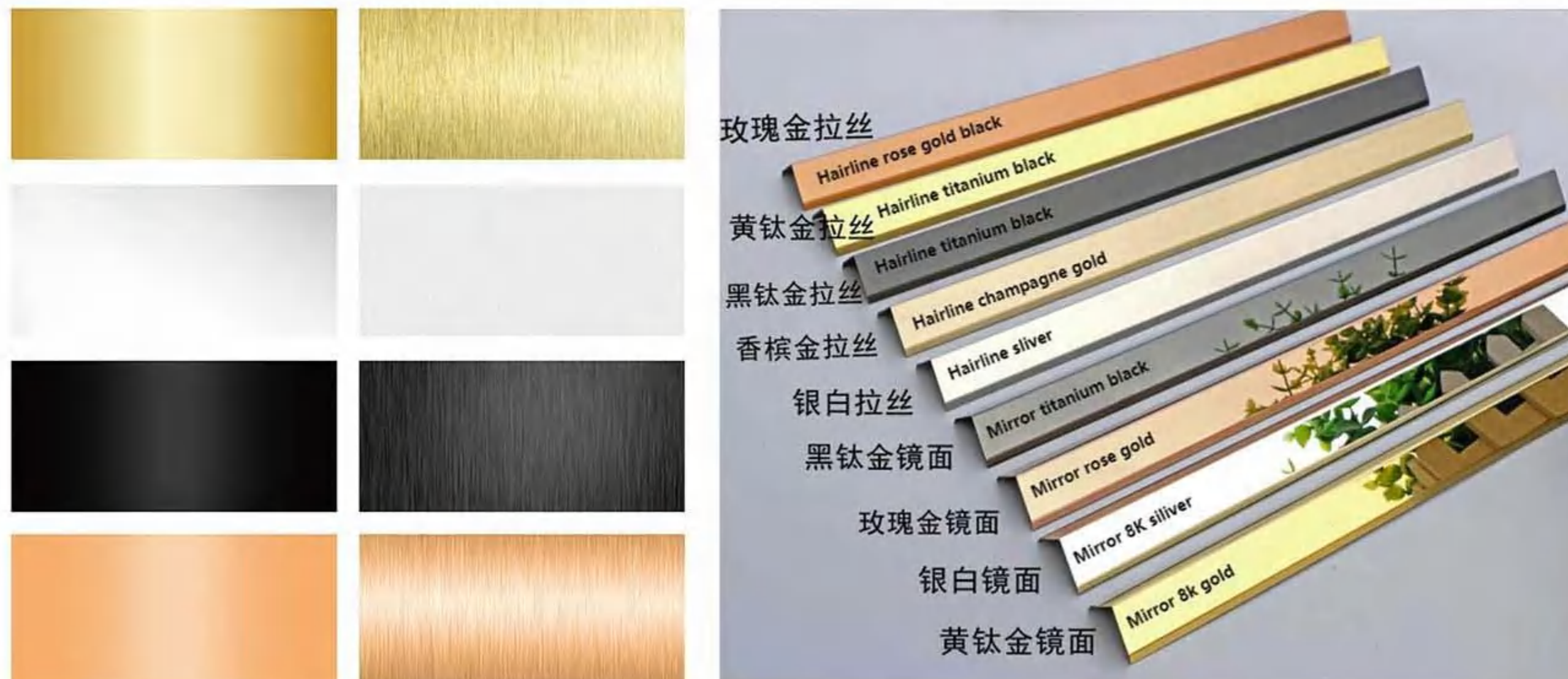

CAD LINE GRAPH

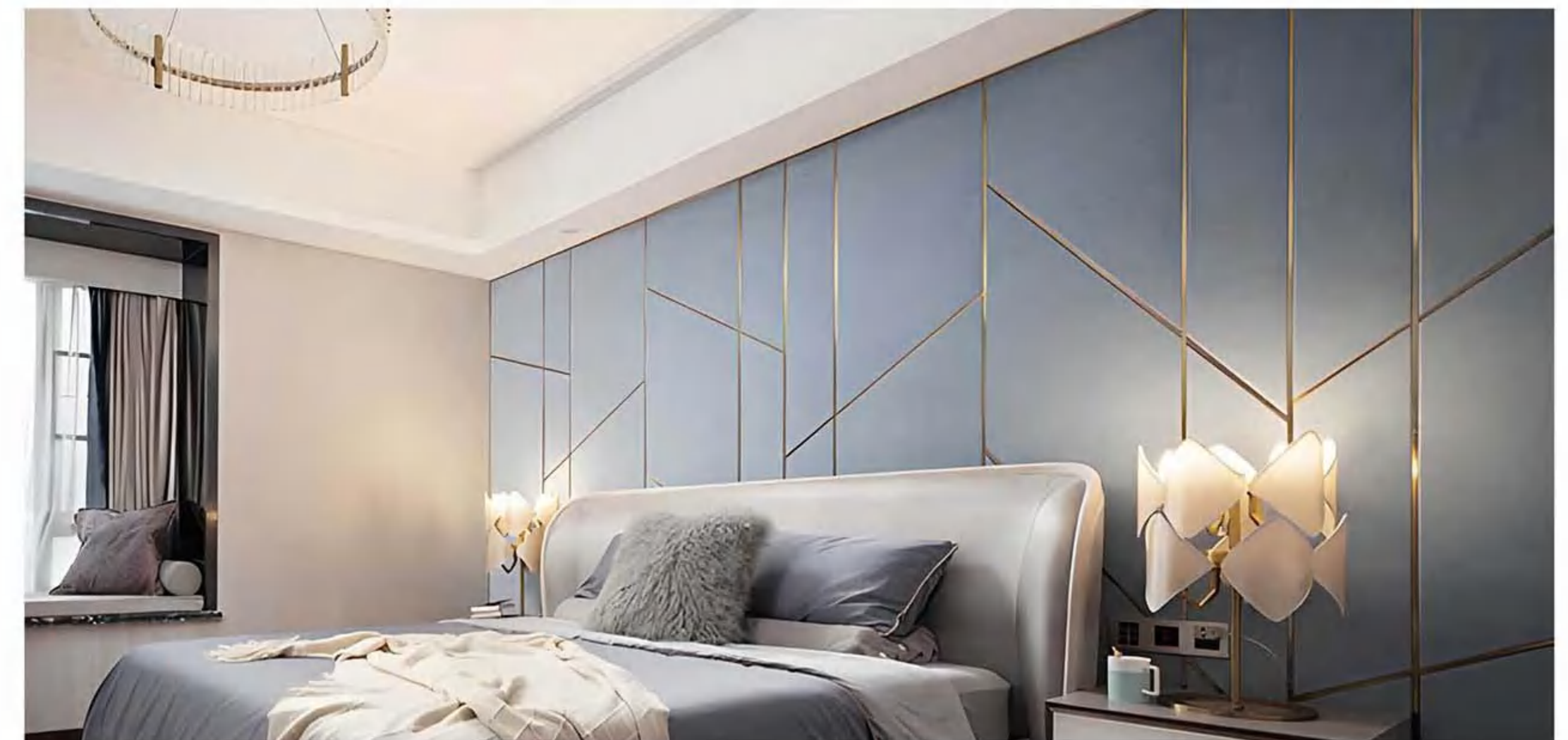
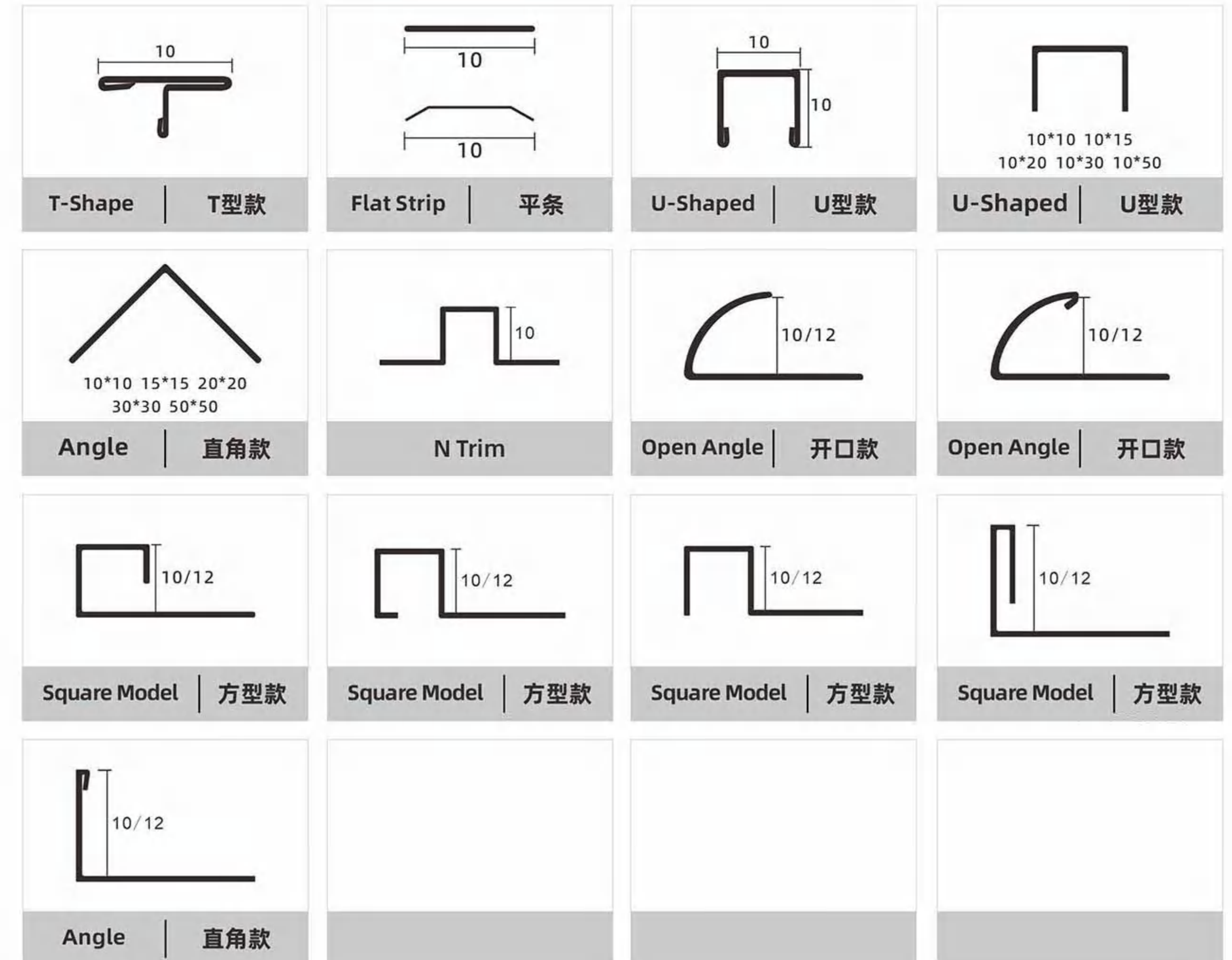

U-shaped

裕益 ROUYI
FREE DESIGN AND OEM

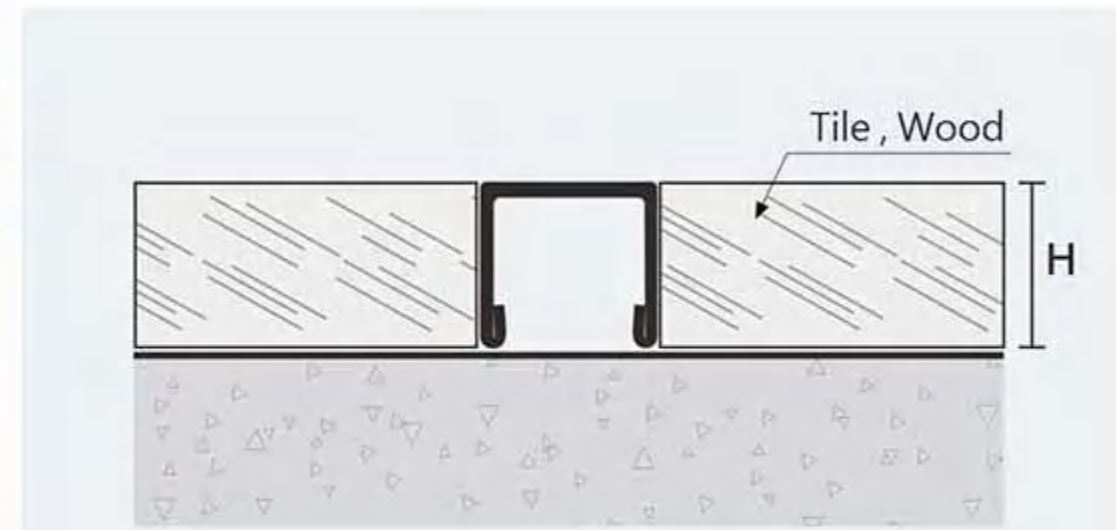

Width	Length	Thickness	Remark
10mm/0.394in	2440~3050mm 8ft~10ft	0.3~1.0(mm) 0.012~0.04in	Size can be customized.
15mm/0.591in			
20mm/0.787in			
25mm/0.984in			
30mm/1.181in			

CAD LINE GRAPH

MODEL SY-U8*10	MODEL SY-U10*10	MODEL SY-U12*10	MODEL SY-U15*10
MODEL SY-U20*10	MODEL SY-U25*10	MODEL SY-U30*10	MODEL SY-U40*10
MODEL SY-U50*10	MODEL SY-U60*10	MODEL SY-U70*10	MODEL SY-U80*10



Open shape



ASSEMBLY DRAWING

Height	Length	Thickness	Remark
8mm/0.315in	2440~3050mm 8ft~10ft	0.5~1.0(mm) 0.02~0.04in	Size can be customized.
10mm/0.394in			
12mm/0.472in			

CAD LINE GRAPH

MODEL SY-Y10*28

MODEL SY-Y12*28

MODEL SY-C10A

MODEL SY-C10B

Square open

ASSEMBLY DRAWING

Height	Length	Thickness	Remark
8mm/0.315in	2440~3050mm 8ft~10ft	0.5~1.0(mm) 0.02~0.04in	Size can be customized.
10mm/0.394in			
12mm/0.472in			

CAD LINE GRAPH

MODEL SY-NF8*8*25

MODEL SY-NF10*10*28

MODEL SY-NF12*12*30

MODEL SY-WF8*8*25

MODEL SY-WF10*10*28

MODEL SY-WF12*12*30

MODEL SY-L8*20

MODEL SY-L10*22

MODEL SY-L12*22

MODEL SY-L15*30

Angle

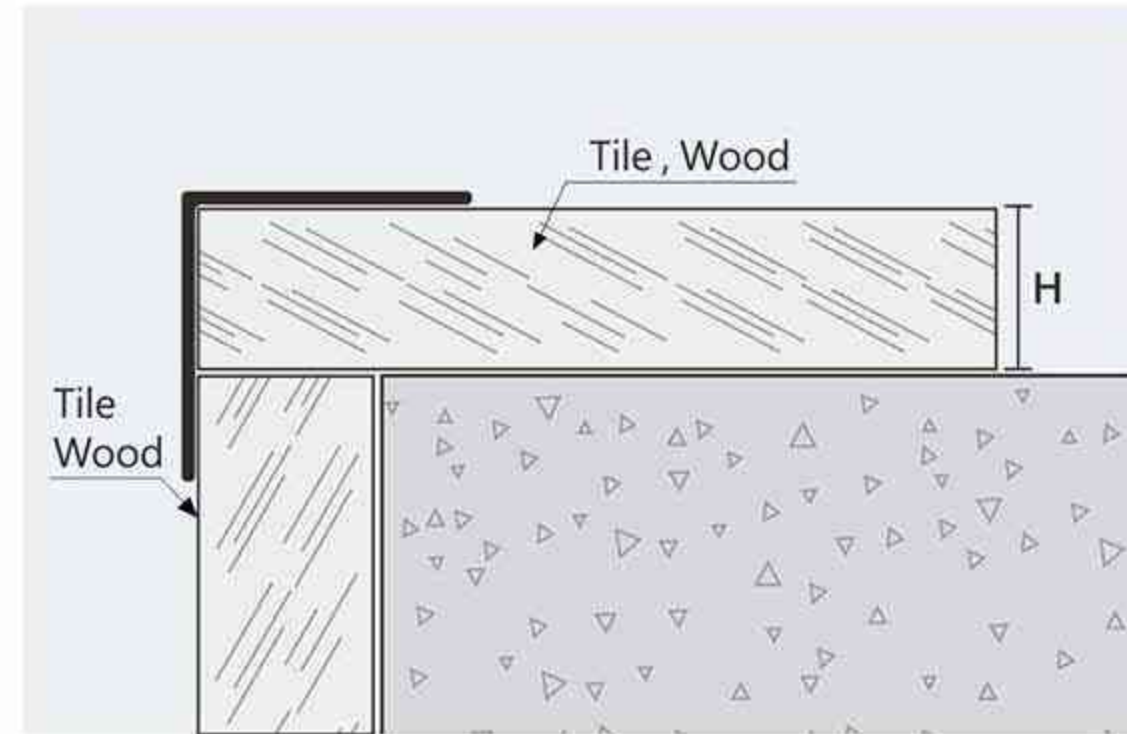

Height	Length	Thickness	Remark
8mm/0.315in	2440~3050mm 8ft~10ft	0.3~1.0(mm) 0.012~0.04in	Size can be customized.
10mm/0.394in			
12mm/0.472in			

CAD LINE GRAPH

<p>MODEL SY-Z12*12</p>	<p>MODEL SY-Z15*15</p>	<p>MODEL SY-Z18*18</p>	<p>MODEL SY-Z20*20</p>
<p>MODEL SY-Z25*25</p>	<p>MODEL SY-Z30*30</p>	<p>MODEL SY-Z40*40</p>	<p>MODEL SY-Z50*50</p>

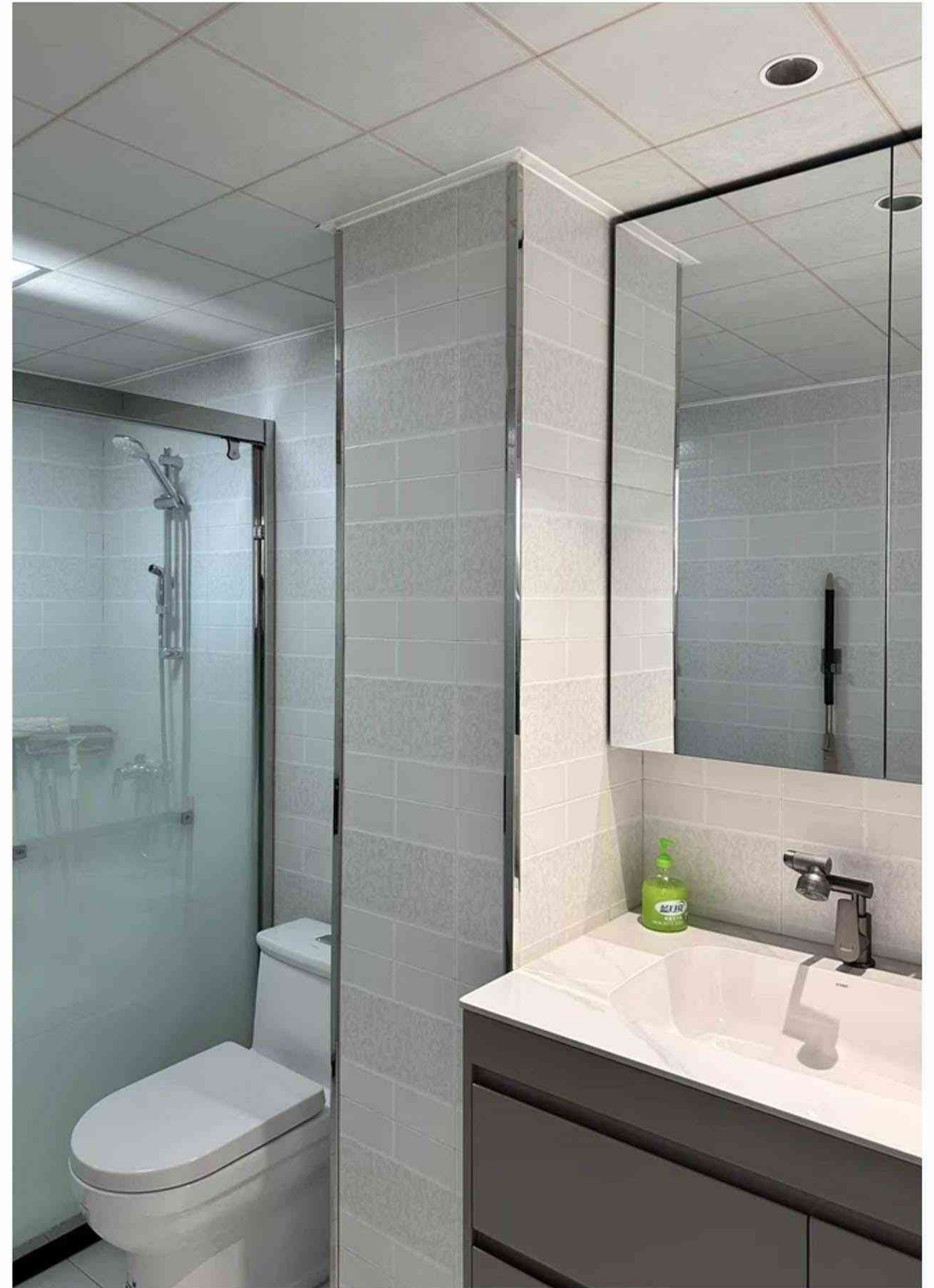

T-shape

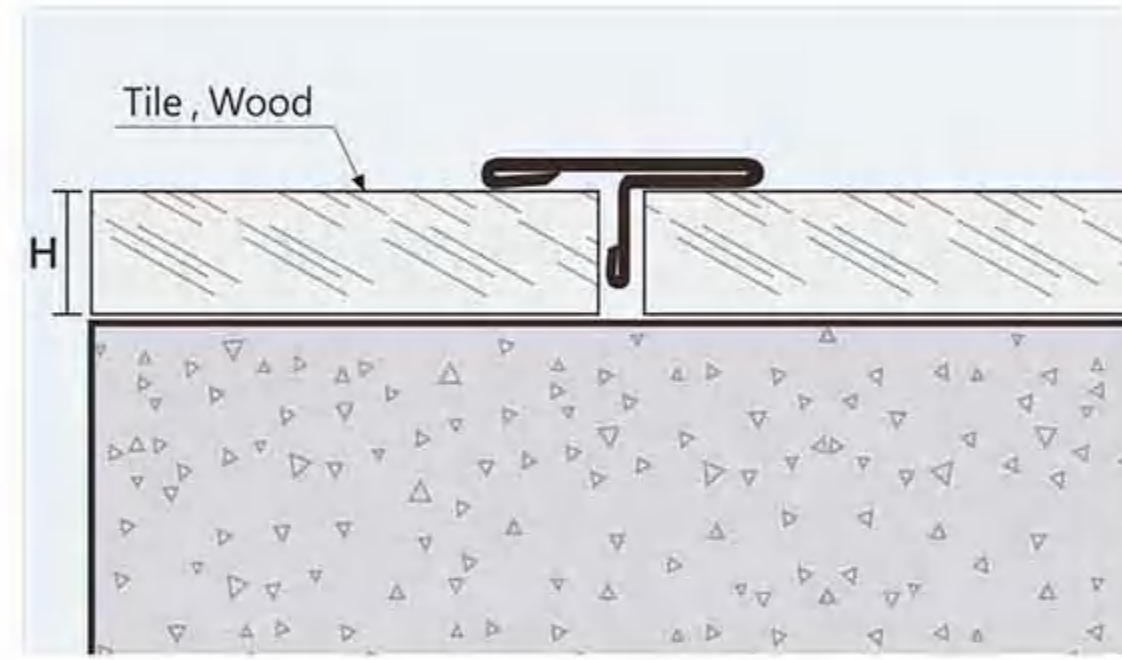

Height	Length	Thickness	Remark
10mm/0.394in	2440~3050mm 8ft~10ft	0.5~1.0(mm) 0.02~0.04in	Size can be customized.
15mm/0.591in			
20mm/0.787in			
25mm/0.984in			
30mm/1.181in			

CAD LINE GRAPH

MODEL SY-T10*4*18	MODEL SY-T10*4*20	MODEL SY-T15	MODEL SY-T25

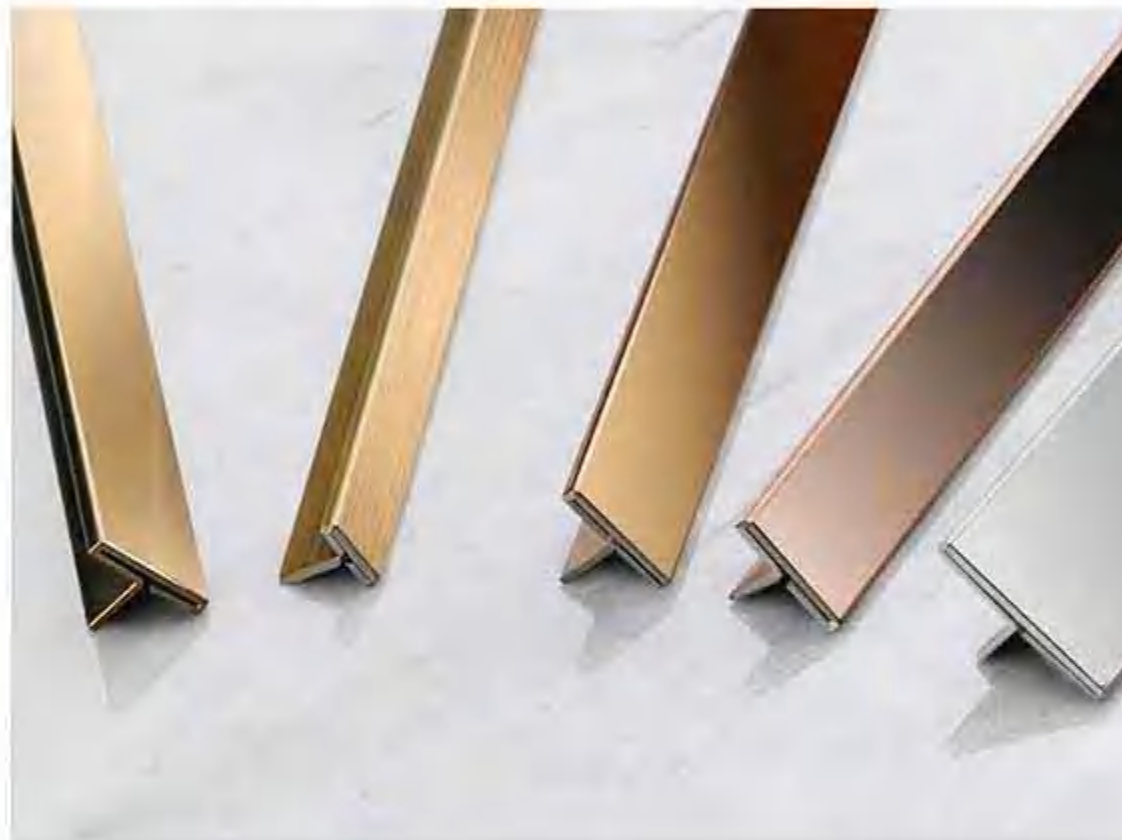

PRODUCT FEATURE

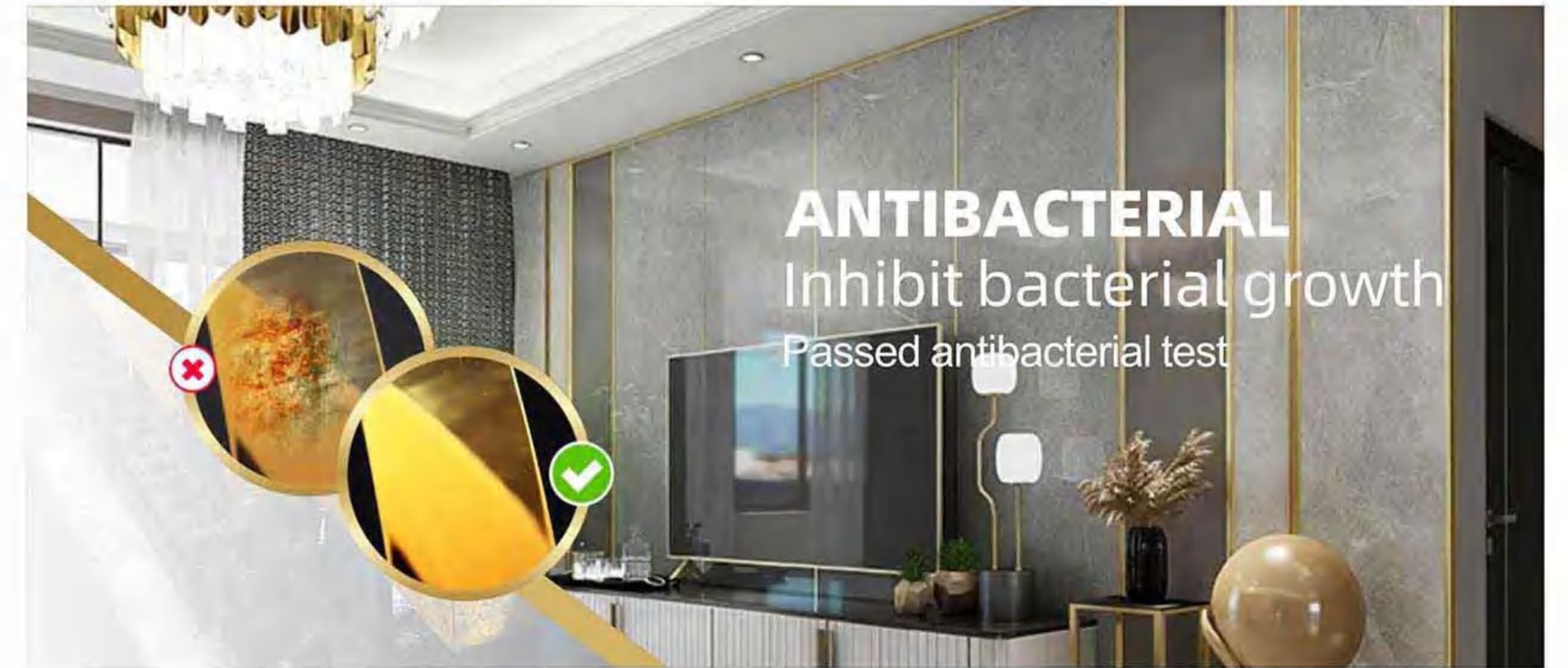
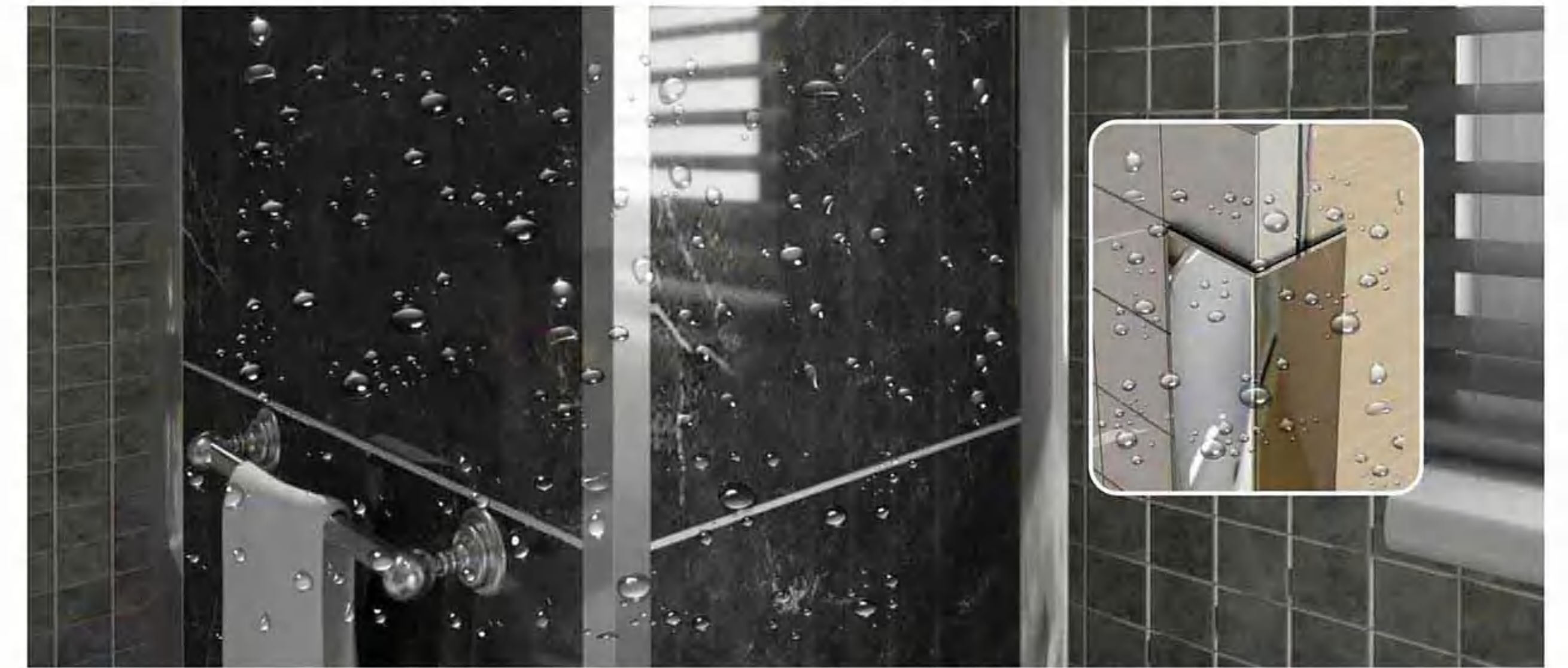

STAINLESS STEEL DECORATIVE STRIP

Meet different decoration requirements

Waterproof



Corrosion resistant



Customized in multiple colors



8K mirror texture



Easy to install



STAINLESS STEEL DECORATIVE STRIP

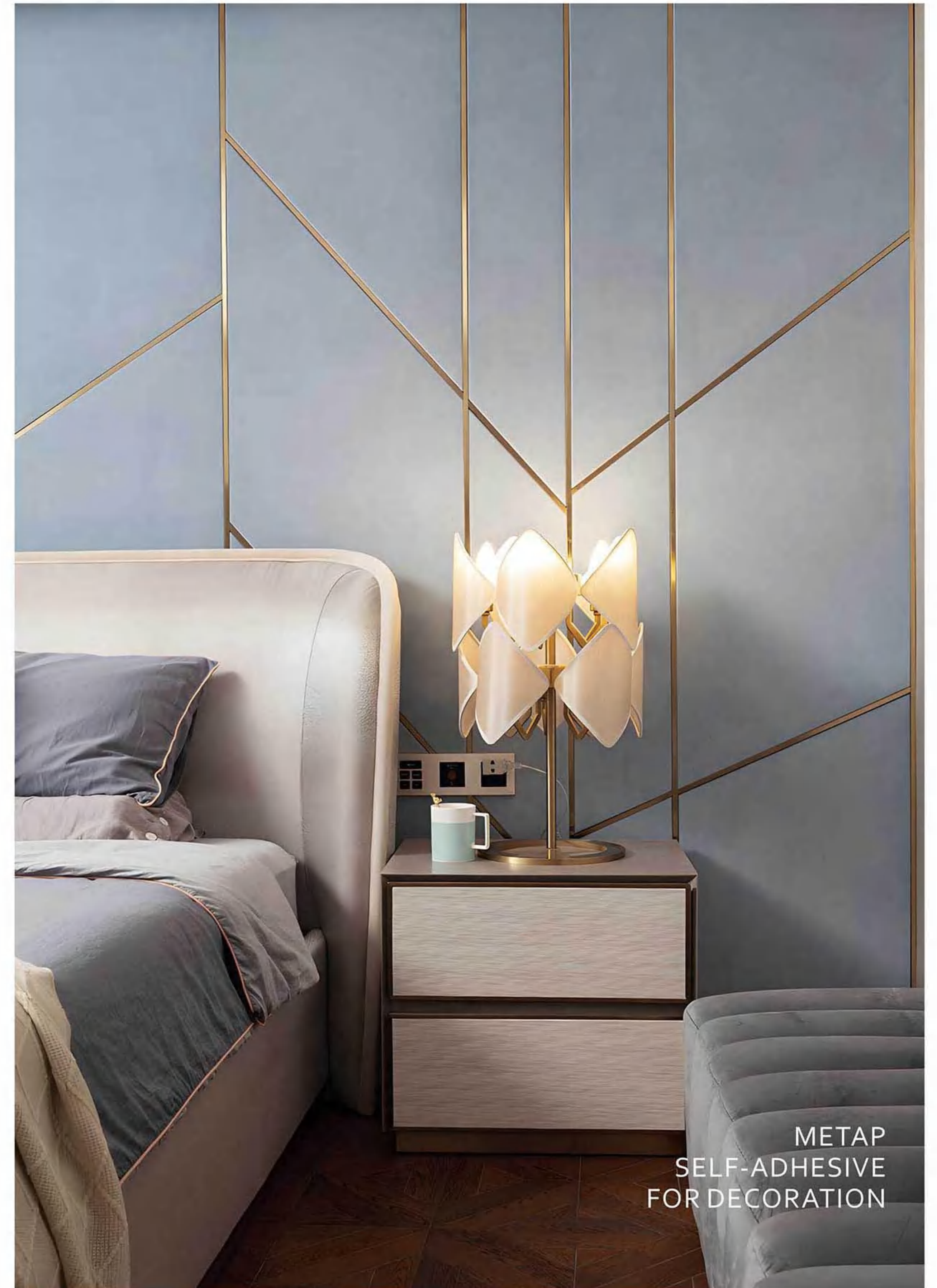

METAP
SELF-ADHESIVE
FOR DECORATION

Skirting board



THICKENED ALUMINUM PROFILE **MEET VARIOUS DECORATION NEEDS**



WELCOME FOR OEM WITH DRAWINGS OR SAMPLES

FREE DESIGN AND OEM

Easy to Install
Formaldehyde-free
Waterproof

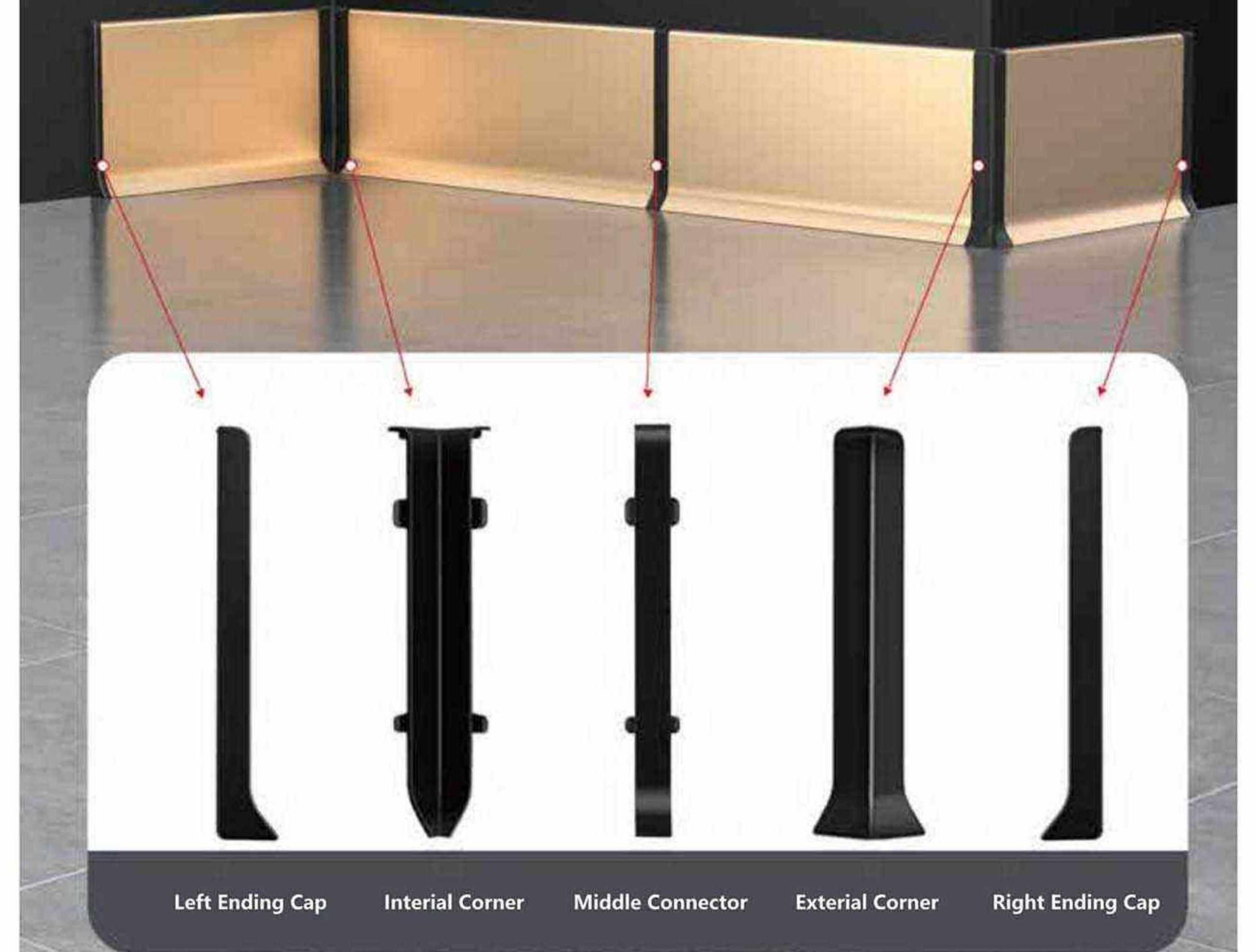

Skirting board

Colors Surface

Any color can be customized



- ◎ Gloss White
- ◎ Matte Silver
- ◎ Matte Black
- ◎ Matte Champagne
- ◎ Matte Grey
- ◎ Matte Gold

CAD LINE GRAPH

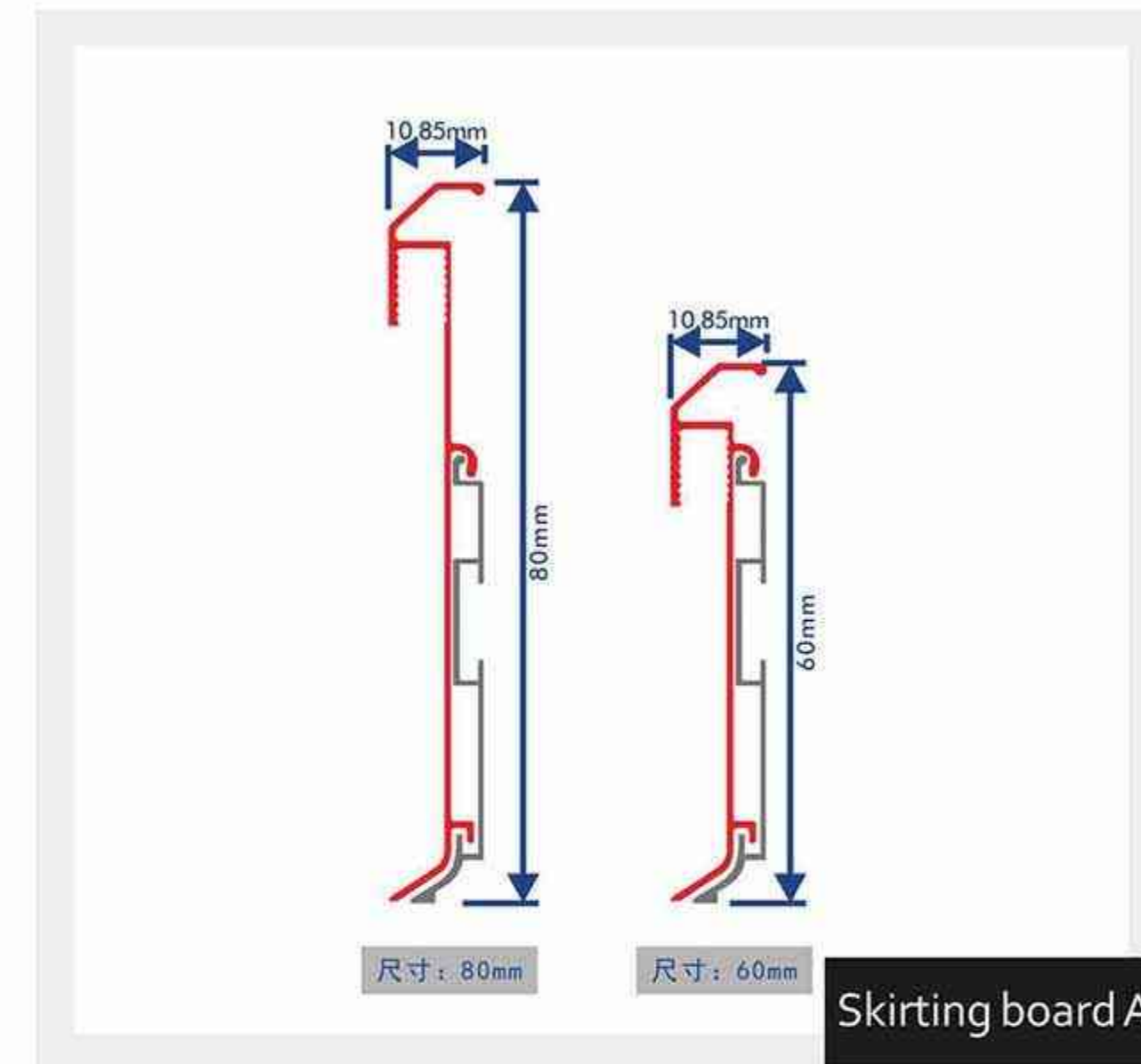
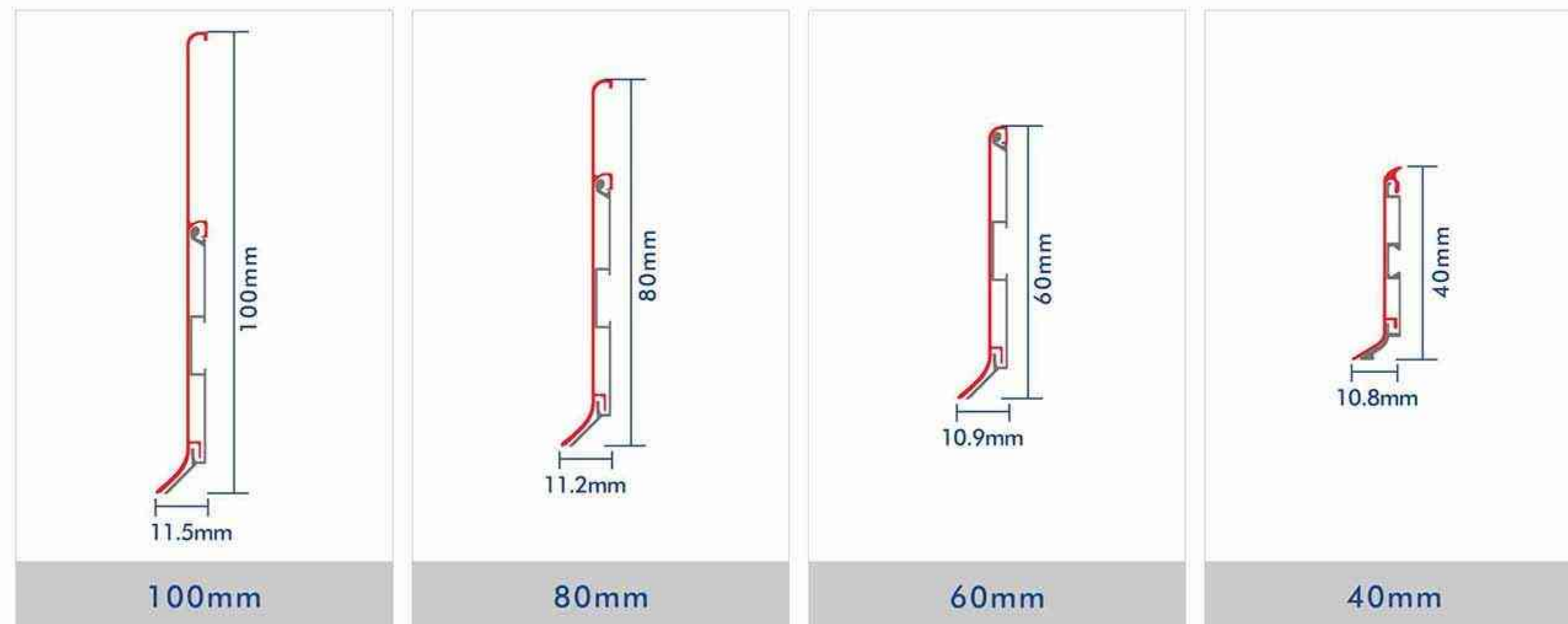

Skirting board A

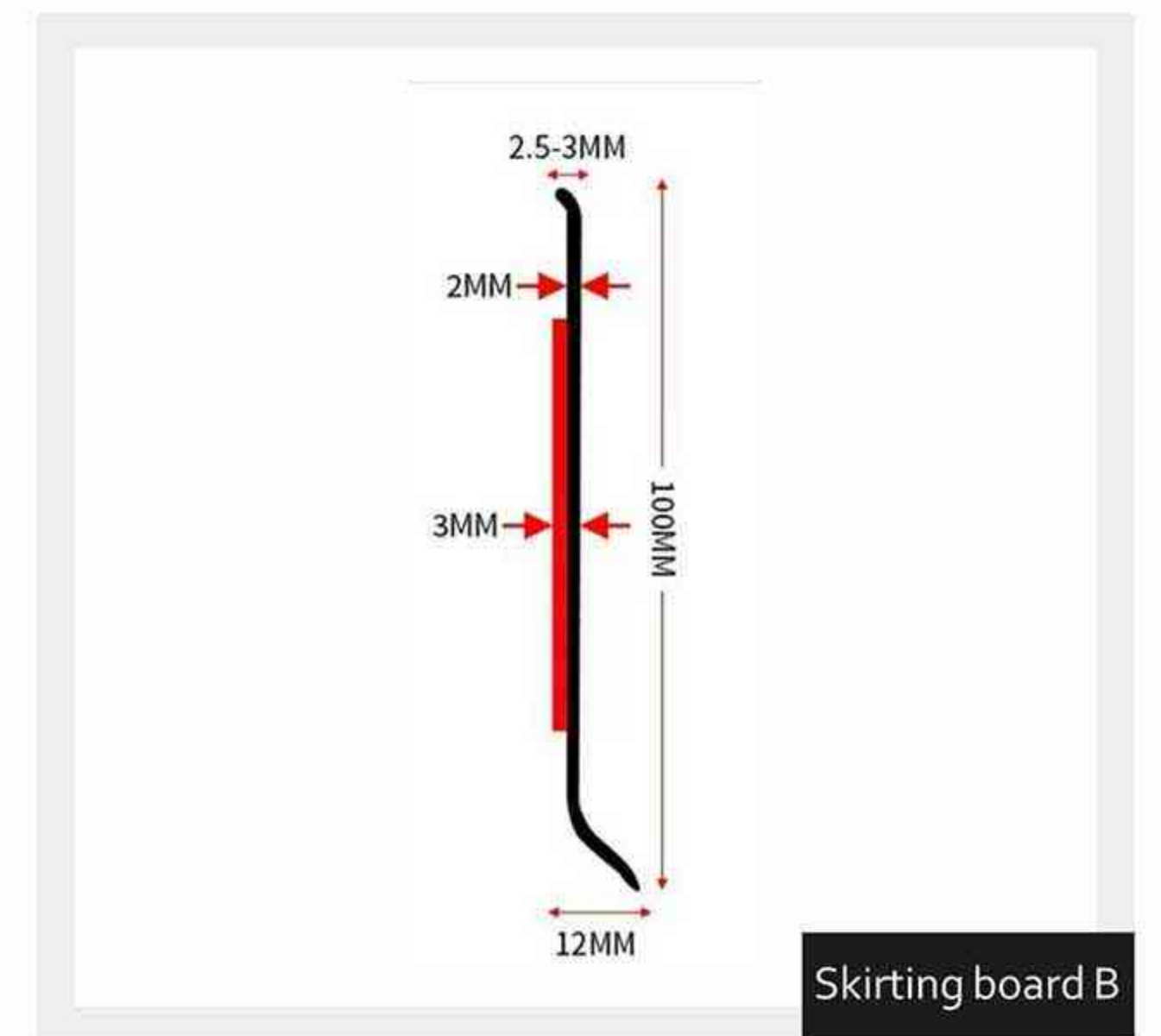

Skirting board B

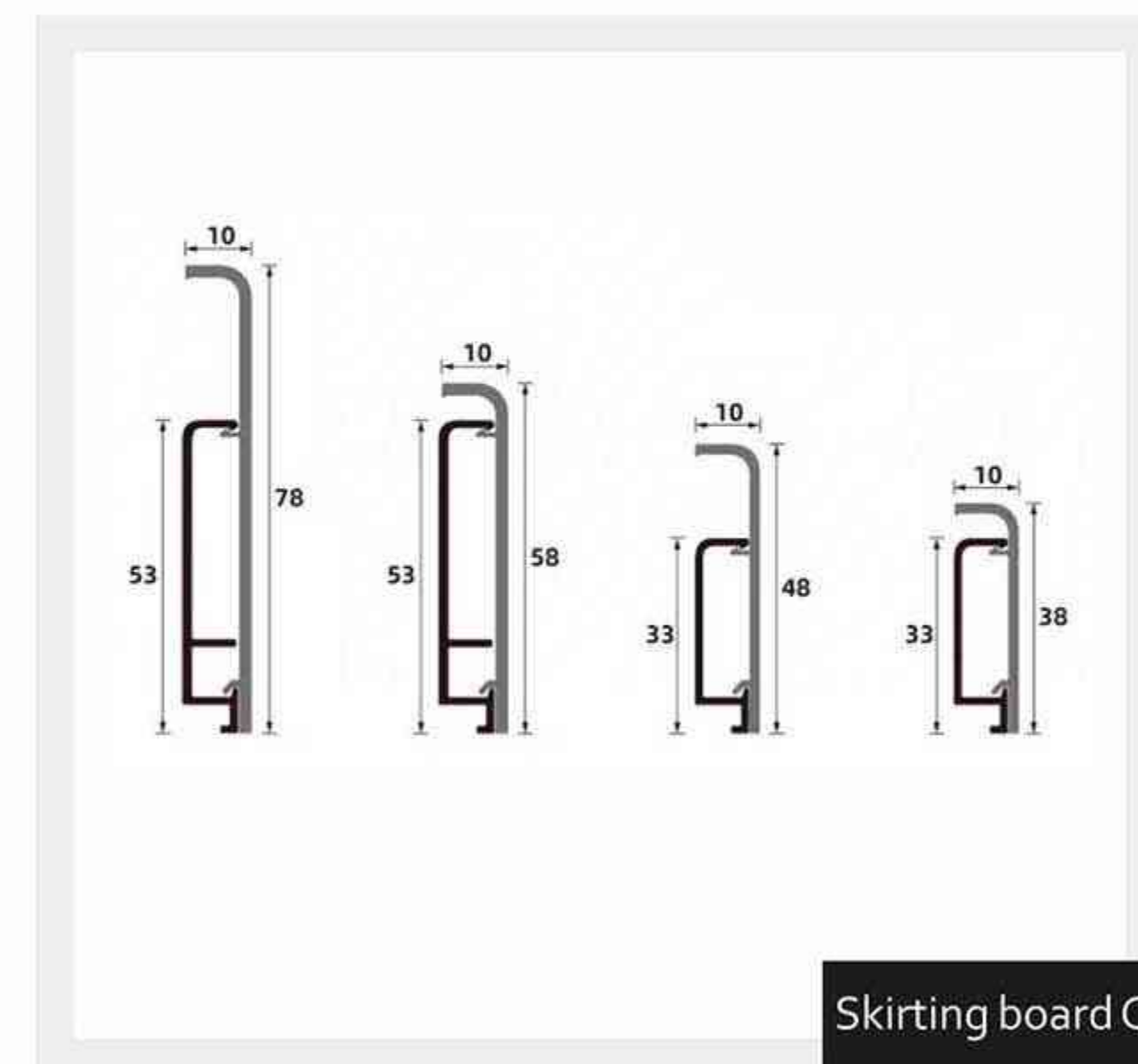

Skirting board C

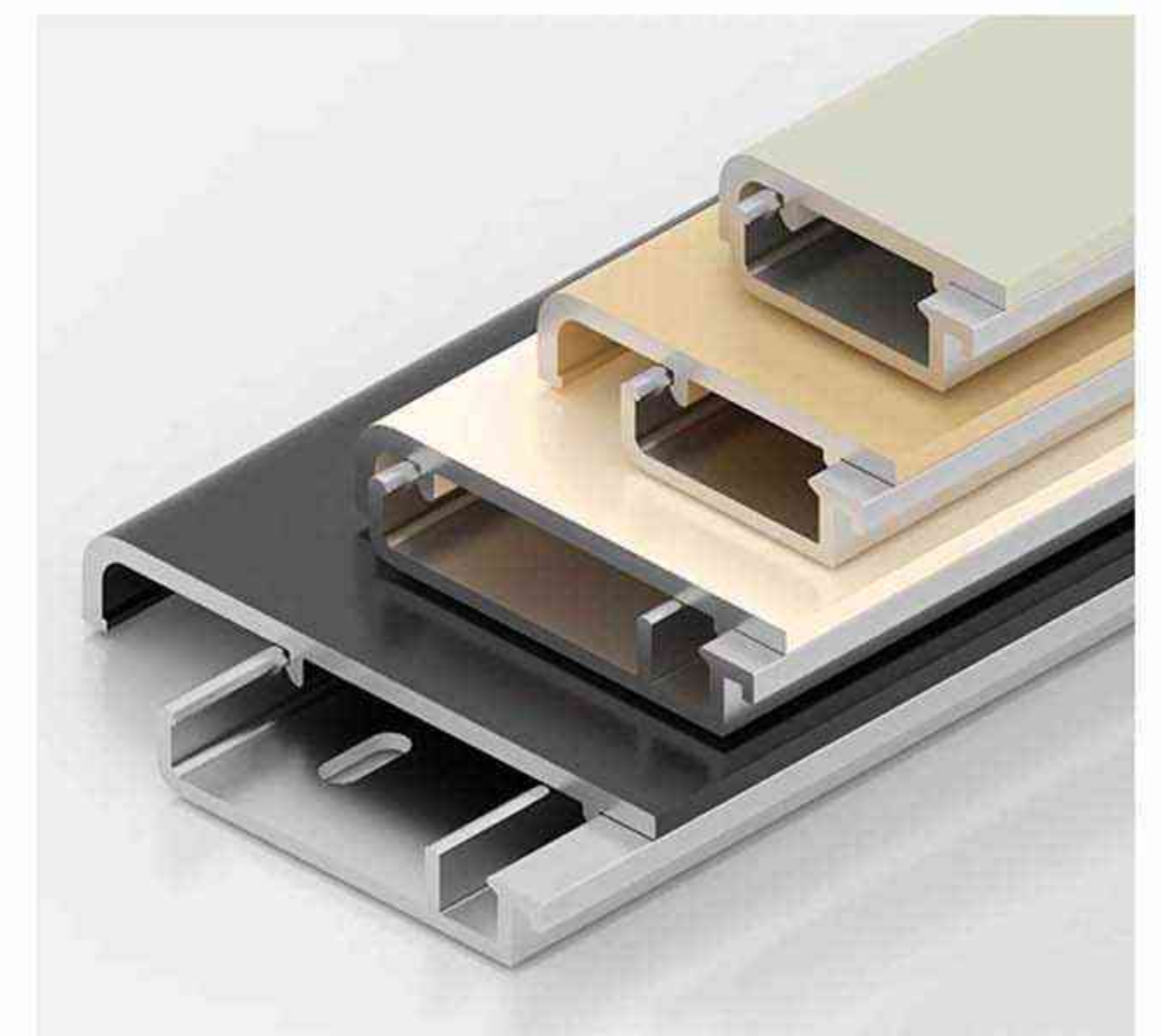

LED PROFILE

High light transmittance and more durable



LED -A



LED -B

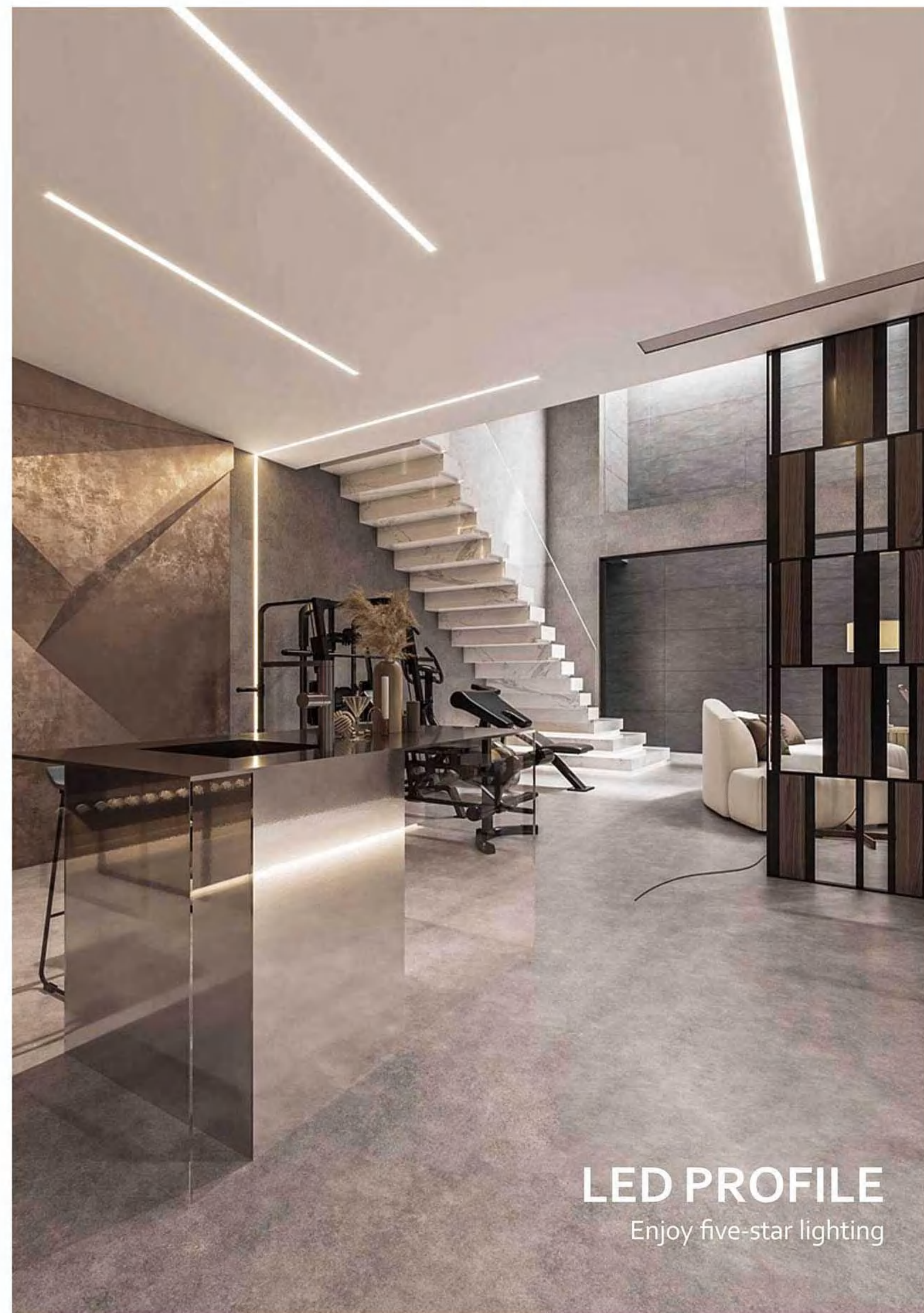
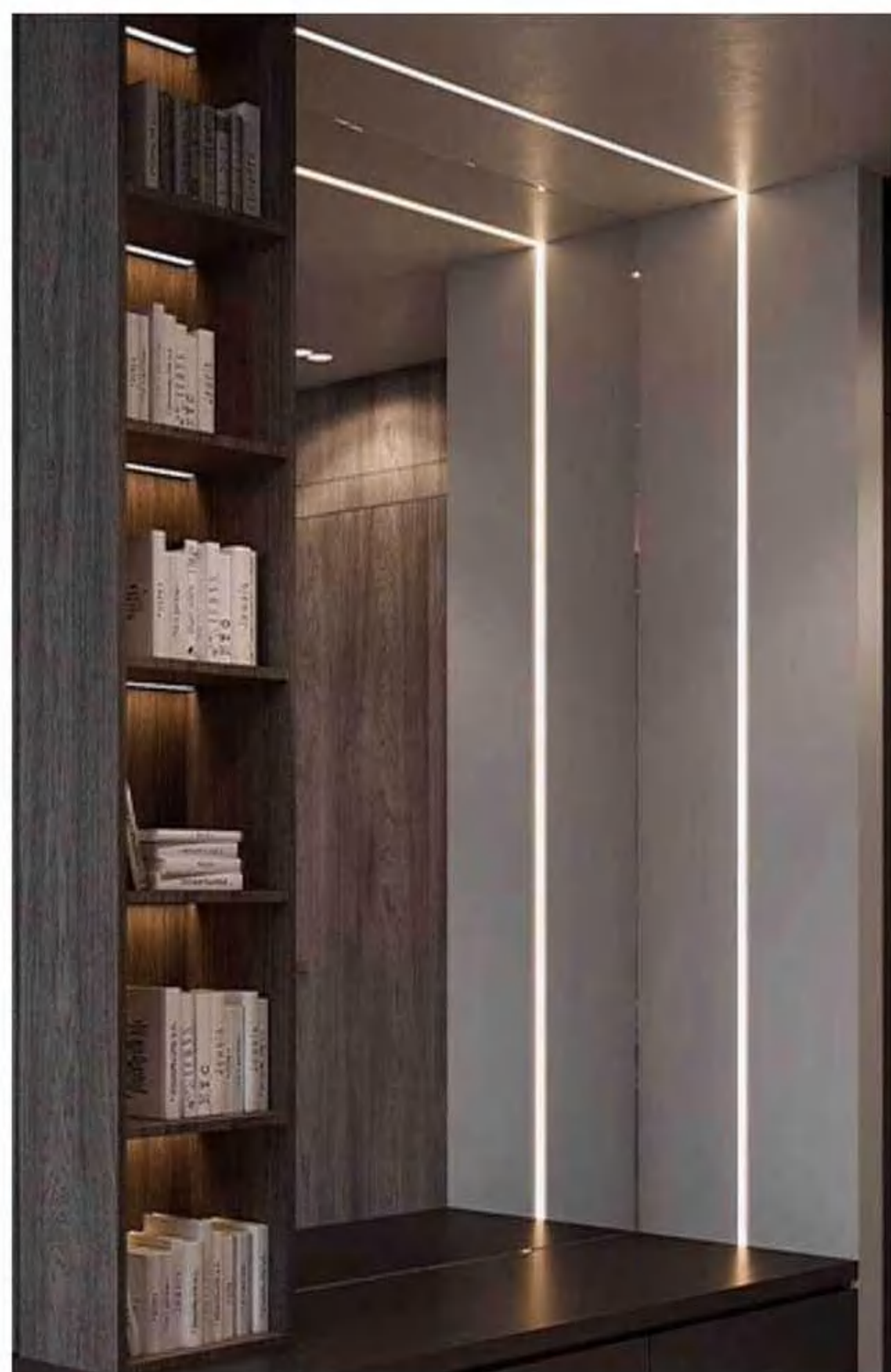

LED PROFILE
Enjoy five-star lighting

LED PROFILE

Decoration layout without owner lights
 home/shop/cinema
 Not easy to turn yellow and not burst, resistant
 to high temperature and cold

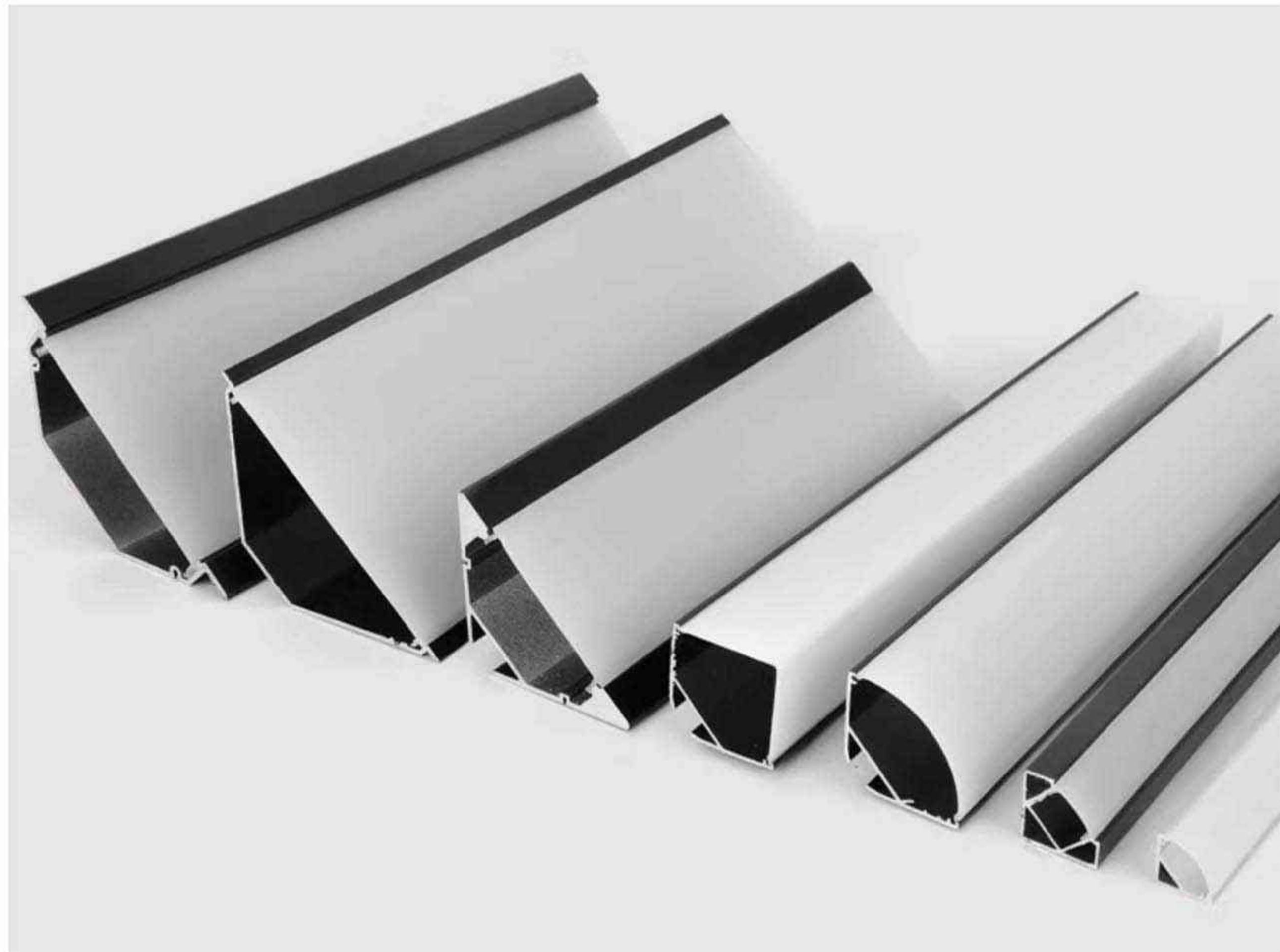
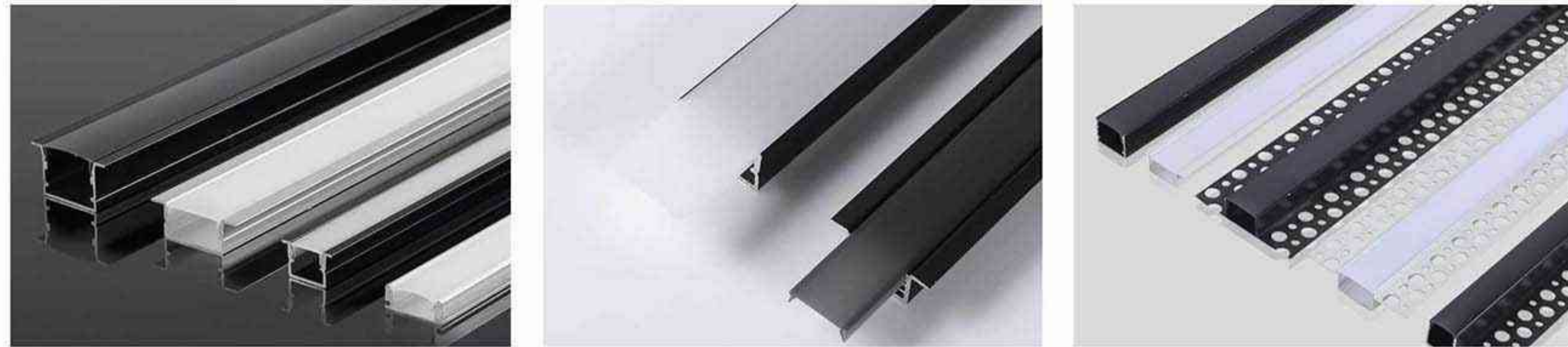

WALL PANEL PROFILE

Wall panel closing styles

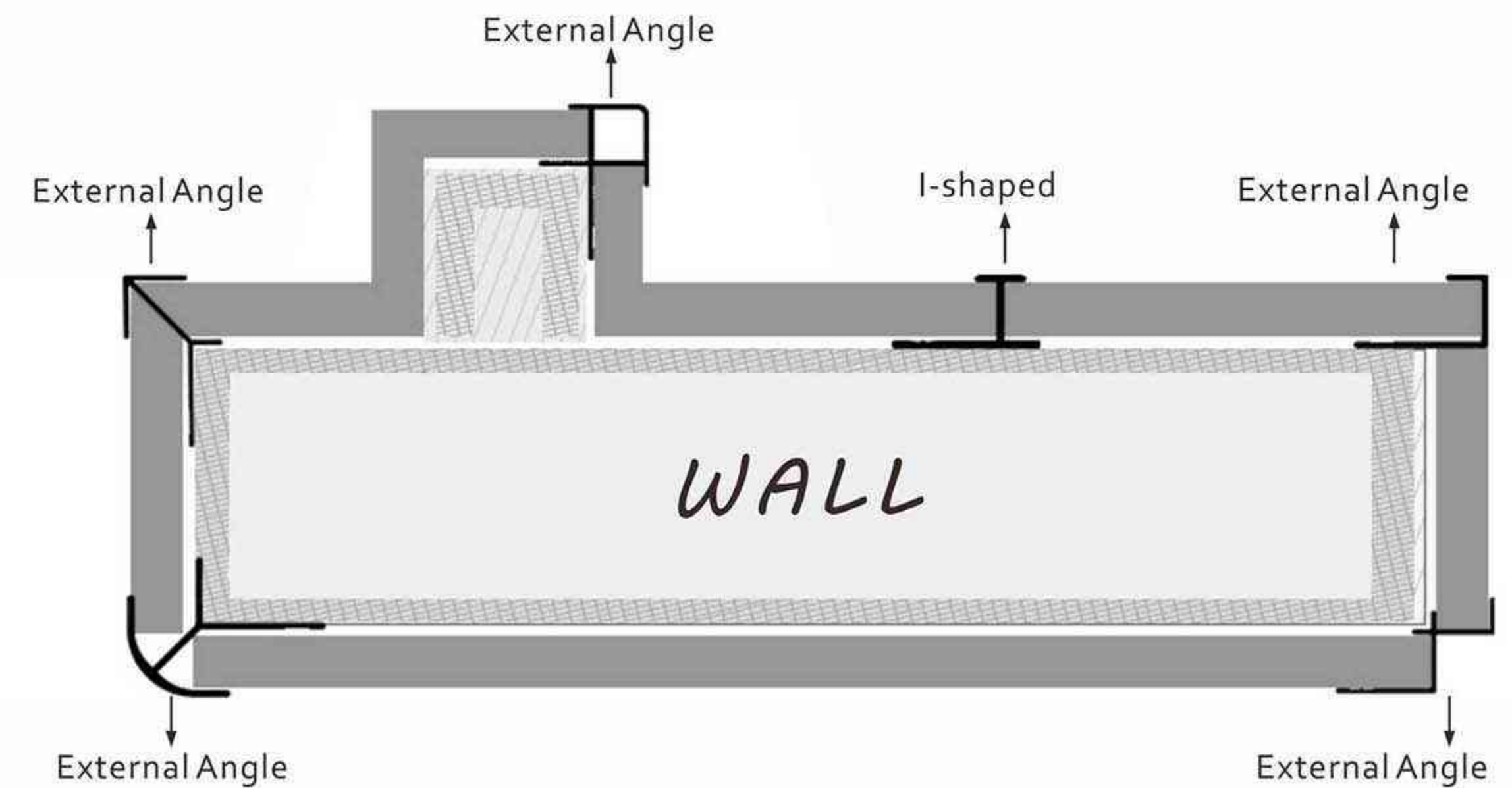
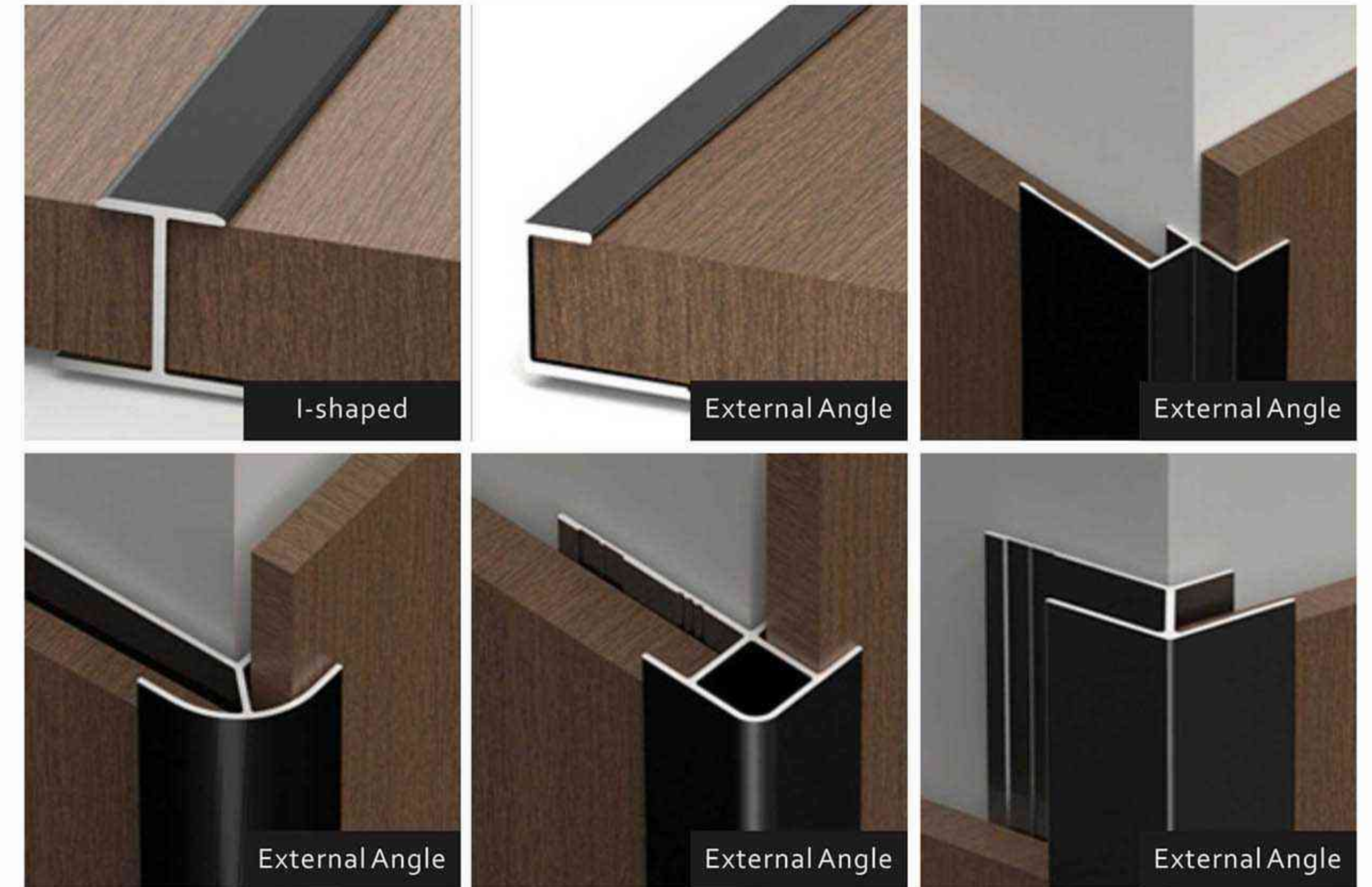

TILE LEVELING SYSTEM

Various specifications available



Adjustable Wrench
Humanized Adjustable Design,
Easy Operation And Convenient
Adjustment



Reusable
Removing It before the cement or tile
glue has completely dried up usually
clean and dry storage for Reuse



Easy To Use
can increase the tile installation speed
and reduce the need for grinding and
polishing, making the tiles flat and
perfect in appearance.

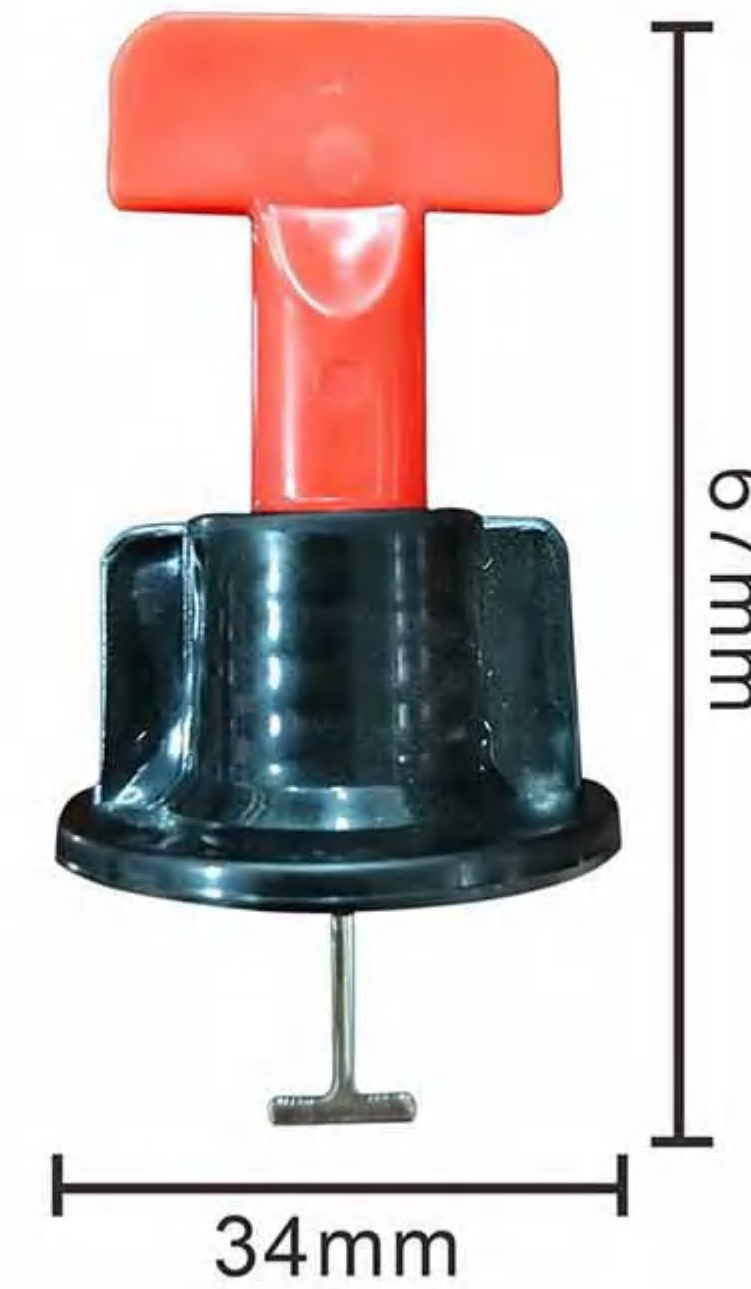

Selected high-strength manganese steel
with deburring by precision grinding;
excellent toughness and strength achieved
through special heat treatment.

Fixed pin design prevents wobbling,
enabling easier construction and improved
construction efficiency.

Replaceable steel needle tile leveler



Fixed pin type tile leveler



TILE LEVELING SYSTEM

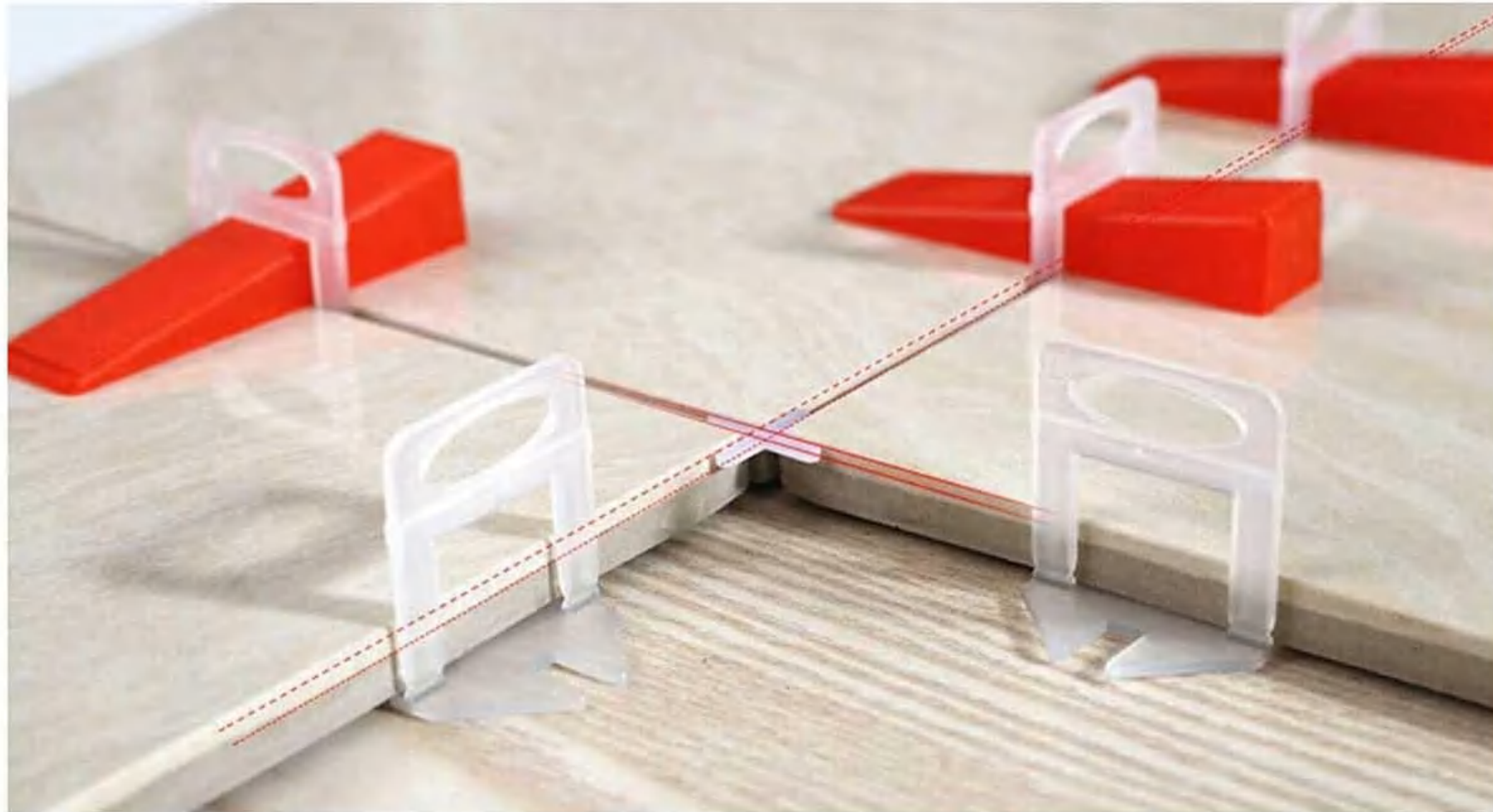

before

after



Tile Leveling System

Prevents the tile from moving during the installation

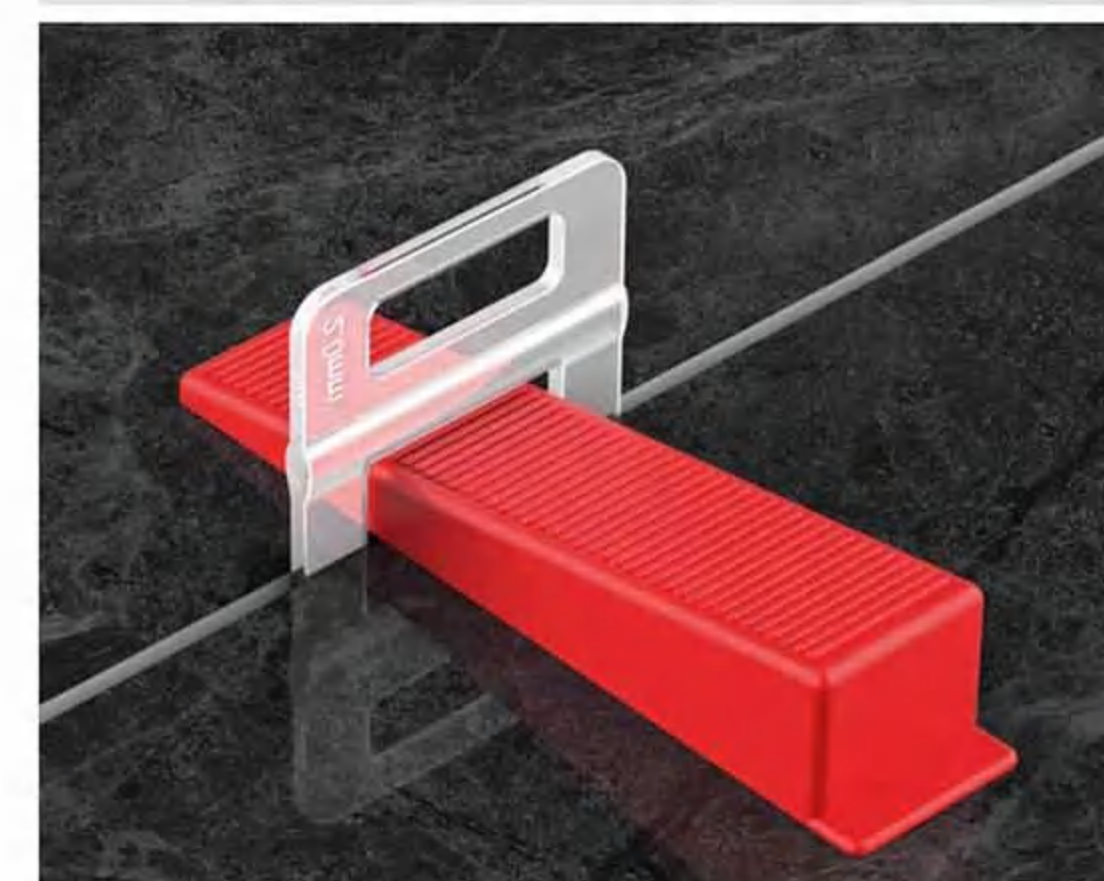

Reinforced and durable wedge

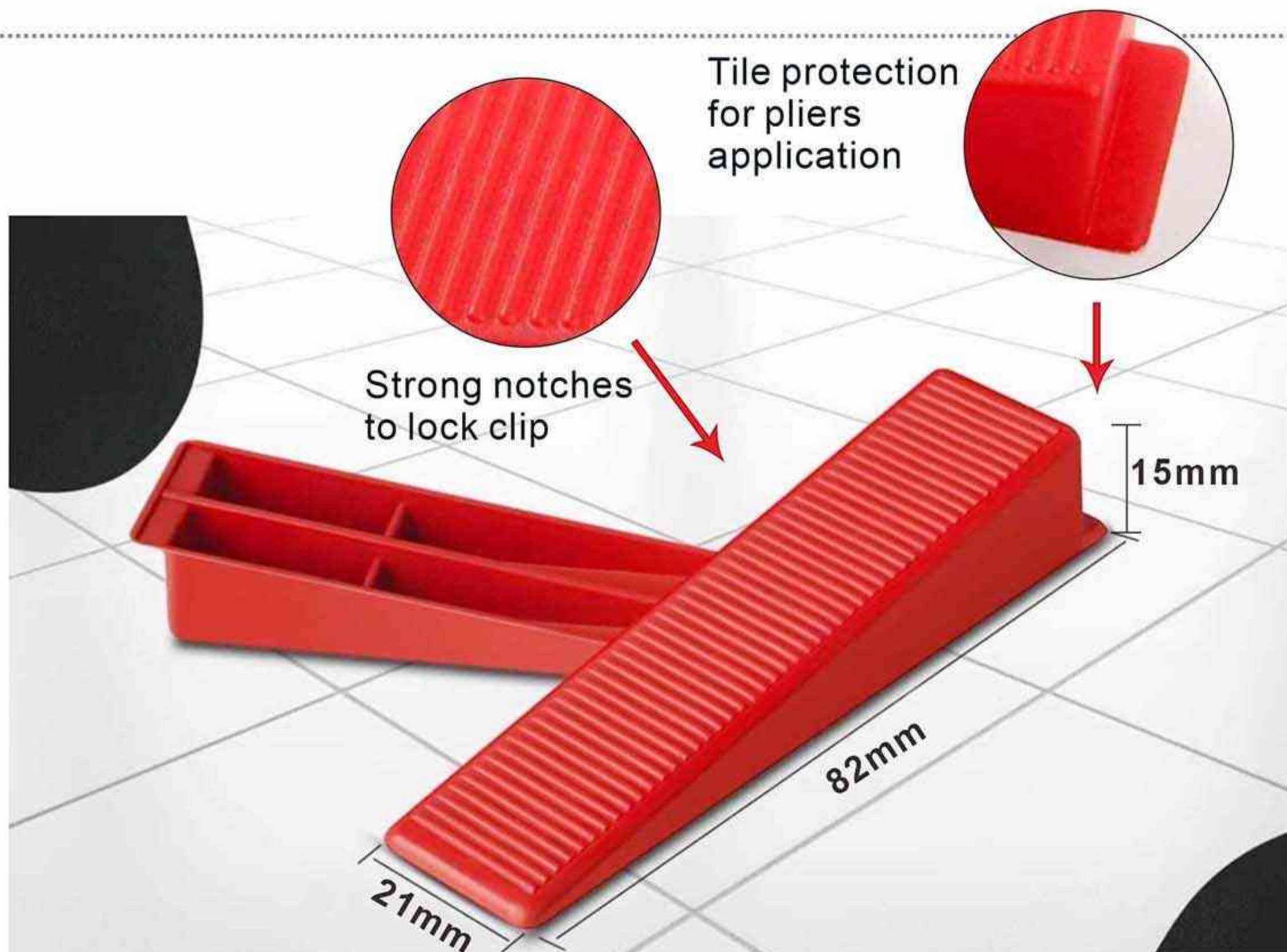

Please pay attention to the width of the wedges and the inner diameter of the clips.

Tile Thickness

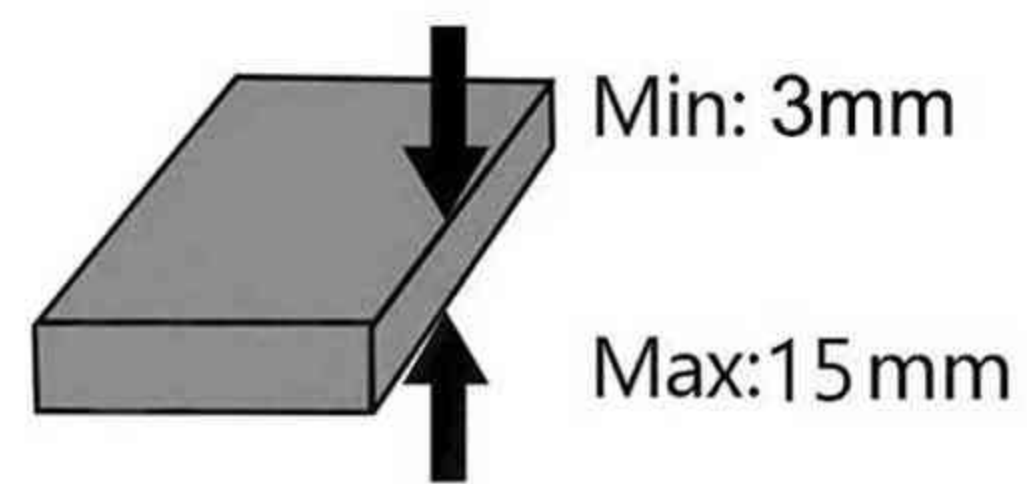

grout lines

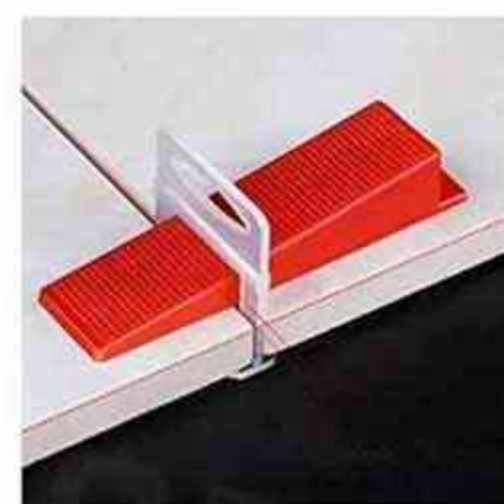
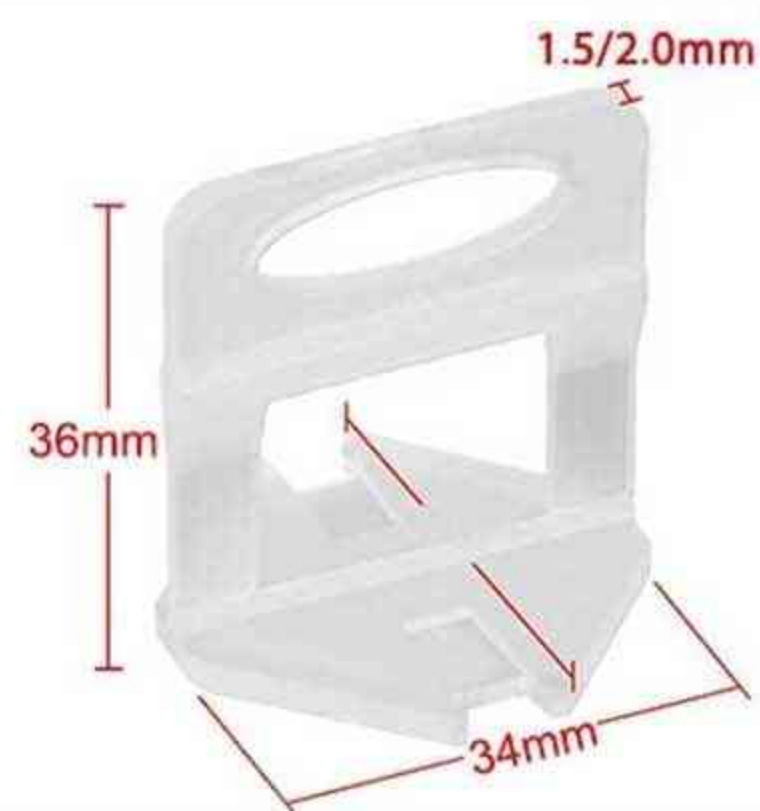
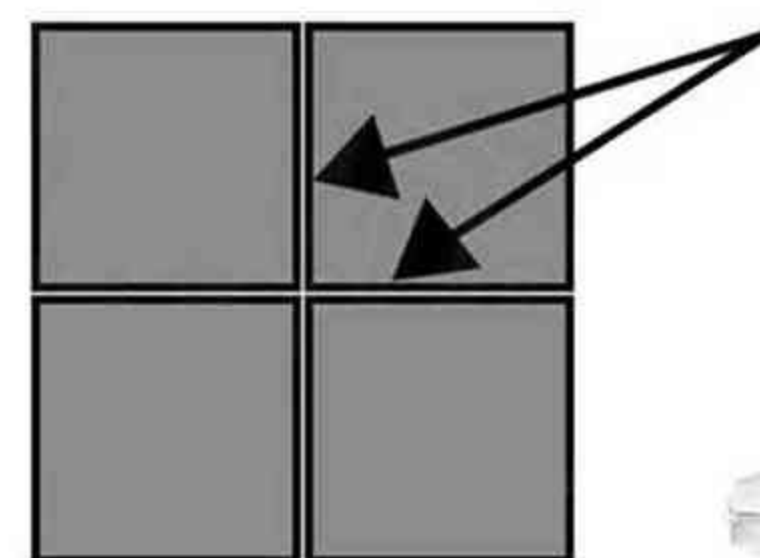

Thick base, stable installation and firmness the same size of the gap

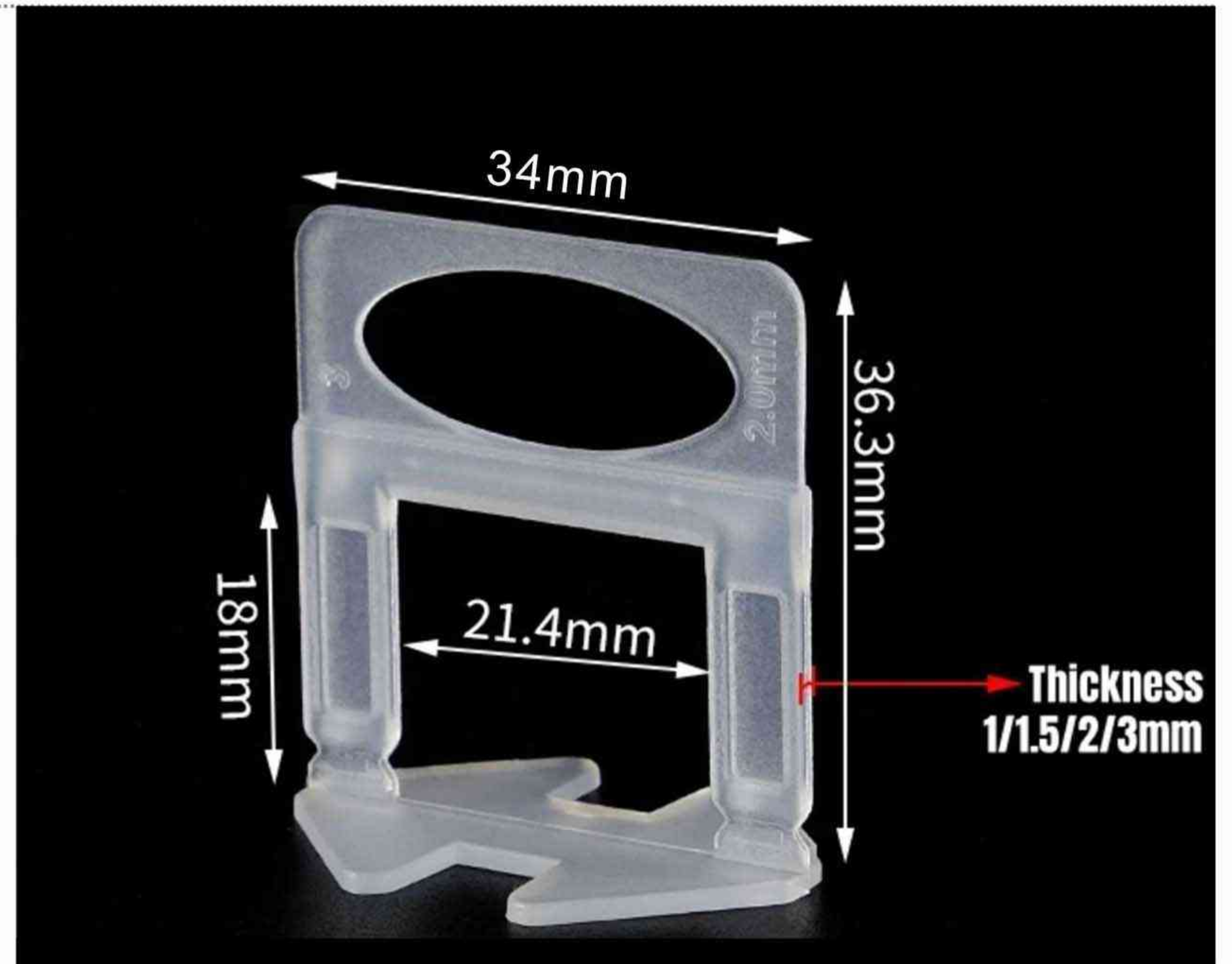

Suitable for tiles with a thickness of 3-12mm.

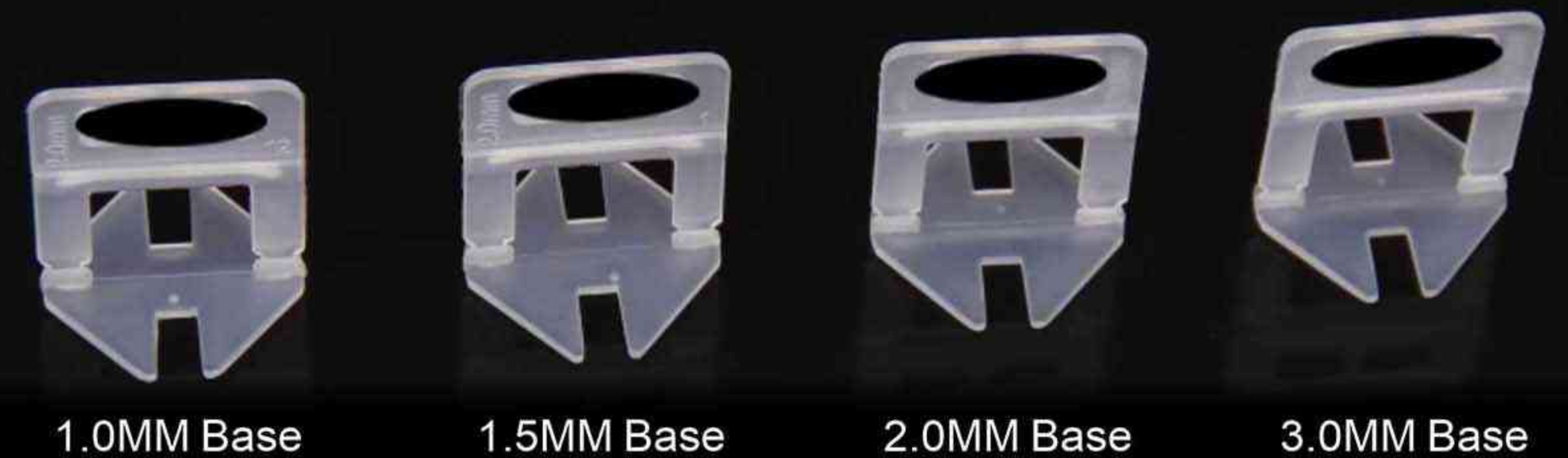

0.35 mm ~ 3mm thickness

ROUYI

PROFESSIONAL EPOXY TILE GROUT
PRODUCTION MANUFACTURER

SUPER GOLDEN PORCELAIN KING

LOGOS/PACKAGES/COLORS

- 01
- 02
- 03
- 04
- 05
- 06
- 07
- 08
- 09
- 10
- 11
- 12
- 13
- 14
- 15
- 16
- 17
- 18



Contact us for more information

SCOPE OF APPLICATION



Good toughness, not easy to break



Auxiliary group tool

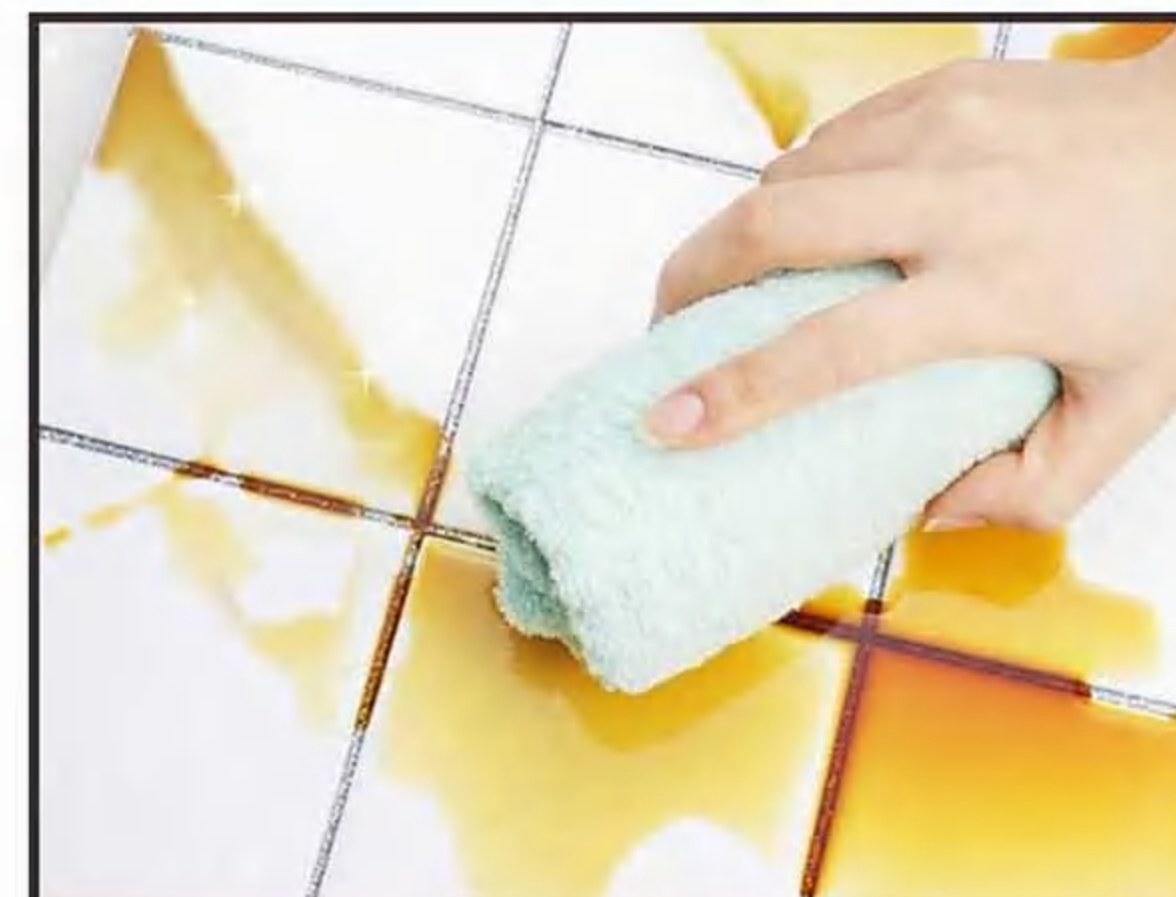

Simple cleaning



Waterproof



Wear and scratch resistant

USE STEPS

SUPER GOLDEN PORCELAIN KING



1

Apply the material to the ceramic gap



2

Press the material into the gap strictly



3

Use different tools according to the size of the gap



4

Let sit for 12 hours without touching



5

Remove excess parts and beautify tiles



6

The effect after applying

PROFESSIONAL EPOXY TILE GROUT PRODUCTION MANUFACTURER

2010 YEAR
SET UP A COMPANY

13 YEAR
INDUSTRY EXPERIENCE

7000 m²
COMPANY AREA

20,000 TONS
ANNUAL PRODUCTIVITY

EFFECT DISPLAY

SUPER GOLDEN PORCELAIN KING

榕益 ROUYI
FREE DESIGN AND OEM

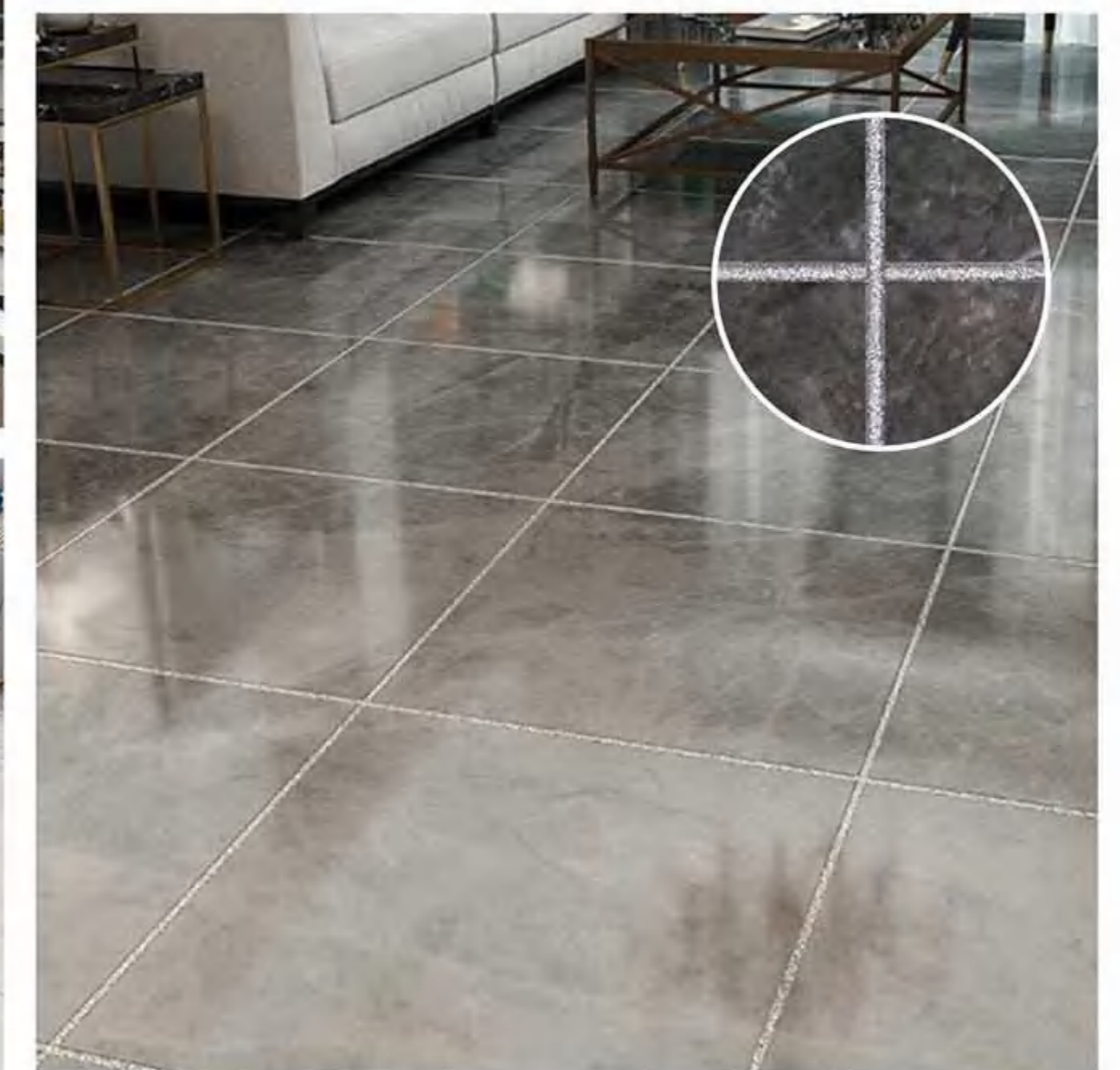

TEAM INTRODUCTION

HIGH-END DECORATION AND TRIMMING SYSTEM



GLOBAL PARTNERS

榕益 ROUYI
FREE DESIGN AND OEM

Exported to **50+** countries
5000+ Annual output
20+ Years export experience

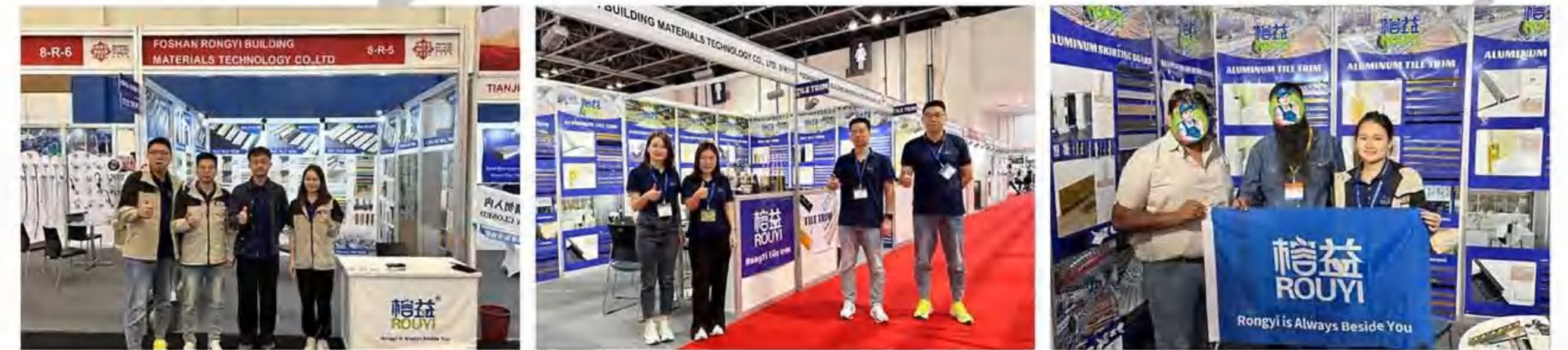

MARKETING EVENTS

